

Operating instructions



Home



General information



Safety instructions



Technical data



Mechanical installation



Electrical installation



Commissioning



Troubleshooting



Disposal

i550 cabinet frequency inverter



0.25 ... 132 kW

General information

Overview

Information

Identification

Conventions

Hardware overview of the inverter

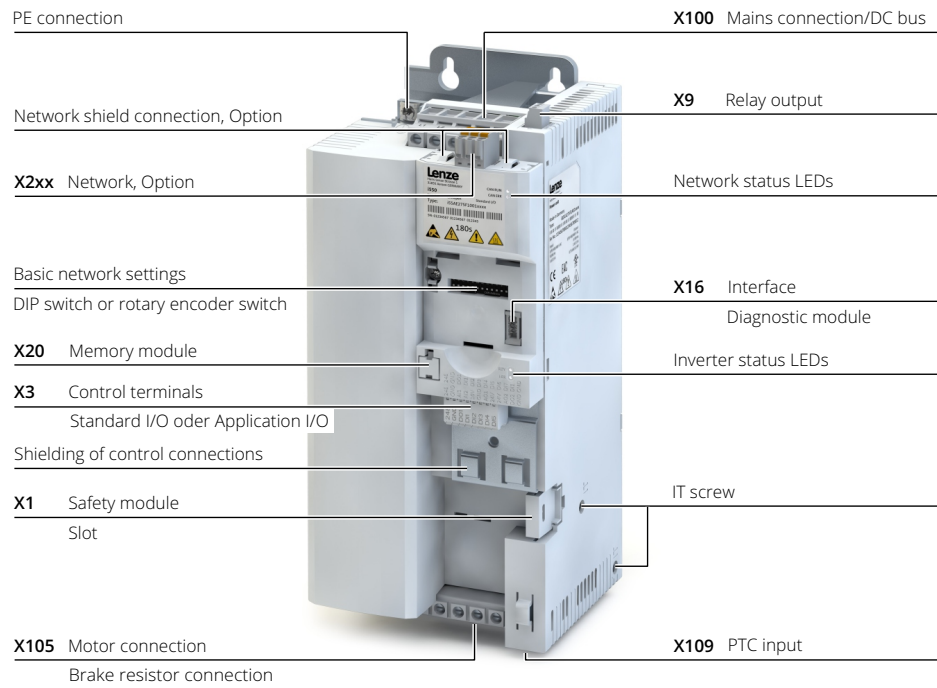

General information

[Overview](#)[Information](#)[Identification](#)[Conventions](#)

Please read this documentation carefully before installing the inverter and observe the safety instructions!

This document only includes the most frequently asked questions and presents them in a simplified form for a better overview. Detailed technical and functional explanations can be found in the comprehensive product documentation. The complete documentation, further information and tools regarding Lenze products can be found on the Internet:

www.lenze.com

Application as directed

- The product is a piece of professional equipment intended for use by trades, specific professions or industry, and not for sale to the general public. IEC 60050 [IEV161-05-05]
- To prevent personal injury and damage to property, higher-level safety and protection systems must be used!
- All transport locks must be removed.
- The product may only be operated under the specified operating conditions and in the specified mounting positions.
- The product is only suitable for installation in control cabinets and, depending on the protection class, for wall mounting.
- The product must only be actuated with motors that are suitable for the operation with inverters.
- The product must not be operated in private areas, in potentially explosive atmospheres and in areas with harmful gases, oils, acids and radiation.

Device-specific standards and directives

- The product meets the protection requirements of the Low-Voltage Directive 2014/35/EU.
- The harmonized standard EN IEC 61800-5-1 is used for the inverters. (Europe).
- UL 61800-5-1 and CAN/CSA C22.2 No.274 are the North American electrical safety standards.

Relevant standards and directives for the operator

- If the product is used in accordance with the technical data, the drive systems comply with the EN IEC 61800-3 categories (Category C2 is similar to FCC Class A).
- The test voltage for insulation resistance tests between a control potential of 24 V and PE must be measured in accordance with EN IEC 61800-5-1.
- The cables must be installed in accordance with EN IEC 60204-1 or US National Electrical Code NFPA 70/Canadian Electrical Code C22.1.

Commissioning

- Commissioning or starting the operation as directed of a machine with the product is prohibited until it has been ensured that the machine meets the regulations of the Machinery Directive 2006/42/EG and the standard EN IEC 60204-1.
- Commissioning or starting the operation as directed is only permissible if the EMC Directive 2014/30/EU is complied with.
- In residential areas, the product may cause EMC interference. The operator is responsible for executing the interference suppression measures.

License information PROFINET

The PROFINET firmware is optional. The PROFINET firmware uses the following open source software packages under a modified GPL license: eCos Operating System. These components are used at the operating system level of the firmware. The protocol stack does not use source code under a GPL license.

View license: <http://ecos.sourceforge.org/license-overview.html>

General information

Overview

Information

Identification

Conventions

Identification of the products

I 5 5 A¹ E 137² F³ 1 A⁴ V 0⁵ 0⁶ 000S⁷

1

Product generation	
A	Generation 1
B	Generation 2

2

Rated power	
125	0.25 kW
137	0.37 kW
155	0.55 kW
175	0.75 kW
211	1.1 kW
215	1.5 kW
222	2.2 kW
230	3 kW
240	4 kW
255	5.5 kW
275	7.5 kW
311	11 kW
315	15 kW
318	18.5 kW
322	22 kW
330	30 kW
337	37 kW
345	45 kW
355	55 kW
375	75 kW
390	90 kW
411	110 kW

3

Mains voltage and connection type	
A	1/N/PE AC 120 V
B	1/N/PE AC 230/240 V
C	3/PE AC 230/240 V
D	1/N/PE AC 230/240 V 3/PE AC 230/240 V
F	3/PE AC 400 V 3/PE AC 480 V

4

Integrated functional safety	
0	Without functional safety
A	Basic Safety - STO

5

Interference suppression	
0	Without interference suppression
1	Integrated RFI filter

6

Application area	
0	Default parameter setting: Region EU (50-Hz networks)
1	Default parameter setting: Region US (60-Hz networks)

7

Design types	
000S	Standard I/O without network
001S	Application I/O without network
002S	Standard I/O with CANopen
003S	Standard I/O with Modbus RTU
004S	Standard I/O with PROFIBUS
012S	Standard I/O with POWERLINK
0xKS	Standard I/O with EtherCAT
0xLS	Standard I/O with PROFINET
0xMS	Standard I/O with EtherNet/IP
0xWS	Standard I/O with Modbus TCP
016S	Standard I/O with IO-Link





General information

Overview

Information

Identification

Conventions

 **Safety instructions** By safety instructions, we mean information for the use of products that serves to warn the user of hazards and to instruct behavior that will not result in harm to people. In this document, these are distinguished as follows according to ANSI Z535.6: **DANGER!** Indicates an extremely hazardous situation. Failure to comply with this instruction will result in severe irreparable injury and even death. **WARNING!** Indicates an extremely hazardous situation. Failure to comply with this instruction may result in severe irreparable injury and even death. **CAUTION!** Indicates a hazardous situation. Failure to comply with this instruction may result in slight to medium injury. **NOTICE** Indicates a material hazard. Failure to comply with this instruction may result in material damage.**Numeric notation**

As a rule, a period is used as a decimal separator in this documentation.

Example: 1234.56

Safety instructions

Basic safety instructions

Residual hazards

Basic safety instructions

DANGER!

Disregarding the following basic safety instructions and safety information may lead to severe personal injury and damage to property!

- Only use the product as directed.
- Never commission the product in the event of visible damage.
- Never modify the product technically.
- Never commission the product before assembly has been completed.
- Never operate the product without the required covers.
- Connect/disconnect all pluggable connections only in deenergized state!
- Only remove the product from the installation in a deenergized state.
- The product can - depending on their degree of protection - have live, movable or rotating parts during or after operation. Surfaces can be hot. Surfaces can be hot.
- Observe all specifications of the corresponding documentation supplied. This is the condition for safe and trouble-free operation and the achievement of the specified product features.
- The procedural notes and circuit details given in the associated documentation are suggestions and their transferability to the respective application must be checked. The manufacturer of the product does not take responsibility for the suitability of the process and circuit proposals.
- All work with and on the product may only be carried out by qualified personnel. IEC 60364 and CENELEC HD 384 define the qualifications of these persons:
 - They are familiar with installing, mounting, commissioning, and operating the product.
 - They have the corresponding qualifications for their work.
 - They know and can apply all regulations for the prevention of accidents, directives, and laws applicable at the place of use.

WARNING!

Functional safety

Certain variants of the product support safety functions (e.g. "Safe Torque Off (STO)") in accordance with the requirements of 2006/42/EC: Machinery Directive [UKCA: S.I. 2008/1597 - The Supply of Machinery (Safety) Regulations 2008]. Be sure to observe the instructions in the documentation regarding the integrated safety technology.

NOTICE

Device protection

Carry out insulation resistance tests between 24-V control potential terminals and PE. The maximum test voltage must not exceed 110 V DC.

NOTICE

Foreseeable misuse

Inverters are not to be operated with DC motors.

Safety instructions

Basic safety instructions

Residual hazards

Residual hazards

The user must take the residual hazards mentioned into consideration in the risk assessment for his/her machine/system. If the above is disregarded, this may result in injuries to persons and material damage!



Dangerous electrical voltage

During operation and up to 20 minutes after power-off, hazardous electrical voltages may be present at the connections of the product.

The leakage current to earth (PE) is > 3.5 mA AC or > 10 mA DC.

Possible consequences

- Death or serious injuries from electric shock

Protective measures

- Any work on the product must only be carried out in a deenergized state.
- Check that no voltage is present!
- After switching off the mains voltage, observe the signs on the product.
- After switching off, wait until the drive is at a standstill.
- Implement the measures required by EN IEC 61800-5-1 or EN IEC 60204-1, i.e. fixed installation and standards-compliant PE connection.

Degree of protection - Protection of persons and device protection

Information applies to the mounted and ready-for-use state.

Motor protection

With some settings of the inverter, the connected motor can be overheated.

- E.g. via the operation of self-ventilated motors at low speeds over a long period.
- E.g. by operating DC-injection braking over a long period.

Product

Observe the warning signs on the product!

Dangerous electrical voltage



Before working on the product, check whether all power connections are deenergized!

After mains disconnection, the power terminals carry the hazardous electrical voltage for the time specified next to the symbol!



Electrostatic sensitive devices

Before working on the product, the staff must ensure to be free of electrostatic charge.



High leakage current

Carry out fixed installation and PE connection in compliance with the following standard:

EN IEC 61800-5-1/EN IEC 60204-1



Hot surface

Use personal protective equipment or wait until the device has cooled down!

Protection of the machine/system

- Drives can reach dangerous overspeeds, e.g. from setting high output frequencies for motors and machines which are not suitable. The inverters do not provide any protection against such operating conditions. Use additional external components for this purpose.
- Only switch the contactor in the motor cable when the inverter is inhibited. Switching them when the inverter is enabled is only permissible when no monitoring components respond.

Motor

In the event of a short circuit of two power transistors, a residual movement of up to 180°/number of pole pairs on the motor may occur (e.g. 4-pole motor): Residual movement max. $180^\circ/2 = 90^\circ$).

Technical data

Standards and operating conditions

Standards and operating conditions

Market approvals		CE (European Union)		Further information and certificates of approval: https://www.lenze.com/en-de/products/inverters/frequency-inverters/i550-cabinet-frequency-inverter
		UKCA (Great Britain)		
		UL (USA)		
		CSA (Canada)		
		CCC (China)		
		EAC (Belarus, Russia, Kyrgyzstan, Kazakhstan and Armenia)		
Environment		RoHS		
Energy efficiency	High Efficiency	EN IEC 61800-9-2	Class IE2	
Degree of protection	EN	EN IEC 60529	IP20	Data applies to operationally ready mounted state and not in wire range of terminals
	NEMA	NEMA 250	Type 1 (only protection against accidental contact)	
Climate	Operation	EN 60721-3-3:1995 + A2:1997	3K3 (-10 ... +60 °C)	Operation at a switching frequency of 2 or 4 kHz: Above +45°C: reduce rated output current by 2.5 %/°C
				Operation at a switching frequency of 8 or 16 kHz: Above +40°C: reduce rated output current by 2.5 %/°C
				Relative humidity < 95 %, condensation not permissible
			3C3	For chemically active substances
			3S2	For mechanically active substances
Power systems			TT, TN	Voltage to earth: max. 300 V
			IT	Apply the measures described for IT systems!
Mains switching		3 x within one minute possible		
Max. motor cable length		device-specific; see technical data in project planning document		
Max. output frequency		0 Hz ... 599 Hz		
Overload capacity		Heavy Duty: 200 % for 3s, 150 % for 60s Light Duty 167 % for 3 s, 125 % for 60 s		

Further standards and operating conditions can be found in the project planning documents.

Mechanical installation

[Important notes](#)[Preparation](#)[Dimensions and assembly](#)

Important notes

NOTICE

UL marking

Modular construction - A complete drive consists of a power unit series no. I5D in combination with a control unit series no. I5C only.

Marquage UL

Conception modulaire – Le système d'entraînement complet comprend un module d'alimentation de série I5D, impérativement associé à une unité de commande de série I5C.

Mechanical installation

Important notes

Preparation

Dimensions and assembly

Mounting of shield connection sheet

I55xE125 ... I55xE240 (optional accessories)

Together with the inverter, the shield connection sheet is screwed onto the mounting plate.

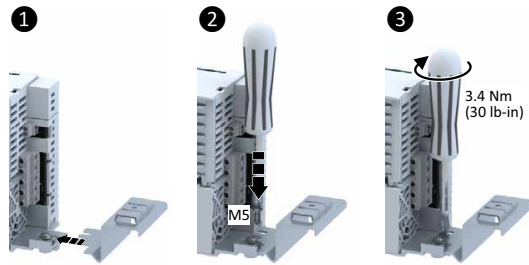

I55AE255 ... I55AE311 (optional accessories)

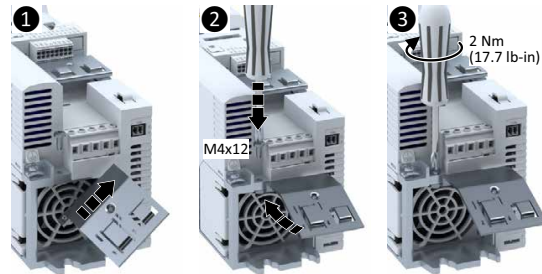

I55BE275 ... I55BE311 (optional accessories)

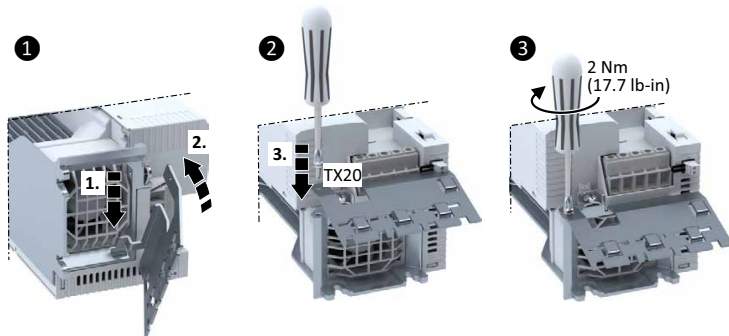

I55AE315 ... I55AE322, I55BE315 ... I55BE330

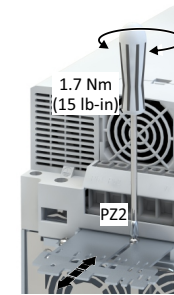

I55AE330 ... I55AE345

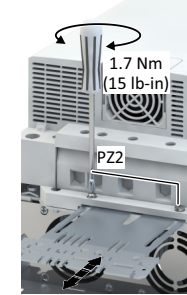

I55AE355 ... I55AE411

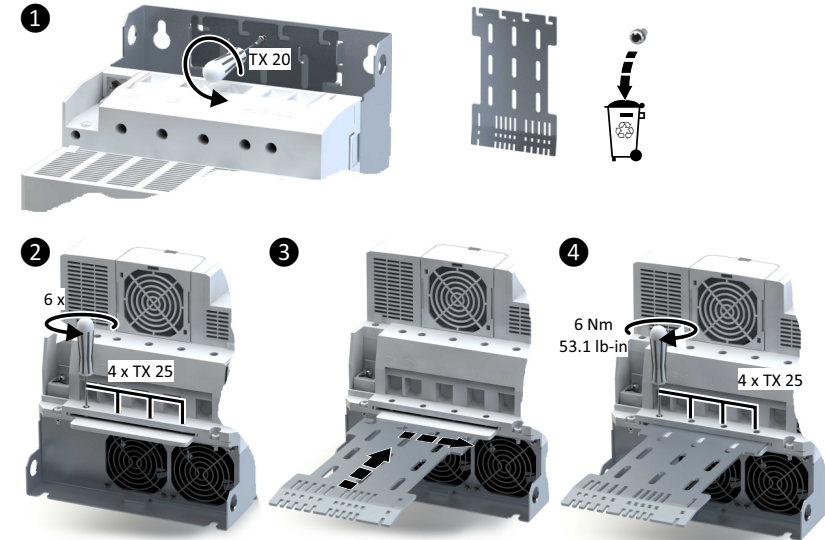

Mechanical installation

Important notes

Preparation

Dimensions and assembly

Dimensions and assembly

NOTICE

The specified installation clearances are minimum dimensions to ensure a sufficient air circulation for cooling purposes. They do not take into account the bending radii of the connecting cables.

Several i5xx cabinet inverters can be mounted directly next to each other, regardless of the device size. No installation clearance is required between the devices.

Inverter	Rated power	Weight	H	B	T	H1	B1	Screws	E1	E2
	[kW]								[kg]	[mm]
1-phase mains connection 120 V devices										
I55AExxxA	0.25 ... 0.37	1	180	60	130	190	-	2x M5	>50	>50
I55AExxxA	0.75 ... 1.1	1.35	250	60	130	260	-	2x M5	>50	>50
1-phase mains connection 230/240 V devices										
I55AExxxB	0.25 ... 0.37	0.8	155	60	130	165	-	2x M5	>50	>50
I55AExxxB	0.55 ... 0.75	1	180	60	130	190	-	2x M5	>50	>50
I55AExxxB	1.1 ... 2.2	1.35	250	60	130	260	-	2x M5	>50	>50
1-/3-phase mains connection 230/240 V devices										
I55AExxxD	0.25 ... 0.37	0.8	155	60	130	165	-	2x M5	>50	>50
I55AExxxD	0.55 ... 0.75	1	180	60	130	190	-	2x M5	>50	>50
I55AExxxD	1.1 ... 2.2	1.35	250	60	130	260	-	2x M5	>50	>50
I55AExxxC	4 ... 5.5	2.1	250	90	130	260	30	4x M5	>50	>100
3-phase mains connection 400/480 V devices										
I55AExxxF	0.37	0.8	155	60	130	165	-	2x M5	>50	>50
I55AExxxF	0.55 ... 0.75	1	180	60	130	190	-	2x M5	>50	>50
I55AExxxF	1.1 ... 2.2	1.35	250	60	130	260	-	2x M5	>50	>50
I55AExxxF	3 ... 4	2.3	250	90	130	260	30	4x M5	>50	>100
I55BExxxF	3 ... 4	1.35	250	60	130	260	-	2x M5	>50	>50
I55AExxxF	5.5	2.3	250	90	130	260	30	4x M5	>50	>50
I55AExxxF	7.5 ... 11	3.7	276	120	130	285	60	4x M5	>50	>100
I55BExxxF	7.5 ... 11	3.7	276	120	130	285	60	4x M5	>50	>100
I55AExxxF	15 ... 22	10.3	347	204.5	222	343	180	4x M6	>50	>100
I55BExxxF	15 ... 30	8	342	180	165	365	154	4x M6	>50	>100
I55AExxxF	30 ... 45	17.2	450	250	230	496	210	4x M8	>95	>130
I55AExxxF	55 ... 75	24	536	250	265	596	210	4x M8	>95	>260
I55AExxxF	90 ... 110	35.6	685	258	304	748	210	4x M8	>95	>260

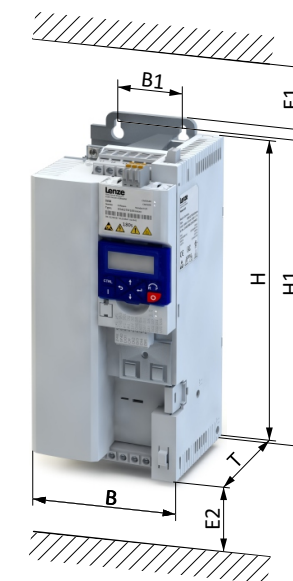

Electrical installation

Preparation | Connection diagram | 1-phase | 120 V | 1-phase | 230/240 V | 3-phase | 230/240 V | 3-phase | 400 V | 3-phase | 480 V | Brake resistor | Control terminals | Relay output

PTC input | Networks | Functional safety | Safe torque off (STO)







Preparation for connection to an IT system

NOTICE

Internal components have ground potential

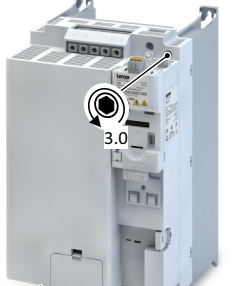
Possible consequence: The monitoring devices of the IT system will be triggered.

- Connect an isolating transformer upstream.
- Before connection to an IT system be absolutely sure to remove the screws marked on the product with "IT".

I55AE125 ... I55AE137	I55AE155 ... I55AE222, I55BE230 ... I55BE240	I55AE230 ... I55AE311, I55BE275 ... I55BE311	
			
I55AE315 ... I55AE322	I55BE315 ... I55BE330	I55AE330 ... I55AE345	I55AE355 ... I55AE411
			

Electrical installation

- Preparation
 - Connection diagram
 - 1-phase | 120 V
 - 1-phase | 230/240 V
 - 3-phase | 230/240 V
 - 3-phase | 400 V
 - 3-phase | 480 V
 - Brake resistor
 - Control terminals
 - Relay output
- PTC input
 - Networks
 - Functional safety
 - Safe torque off (STO)

Connection diagram

The connection diagram is considered exemplary for all voltage and power classes.

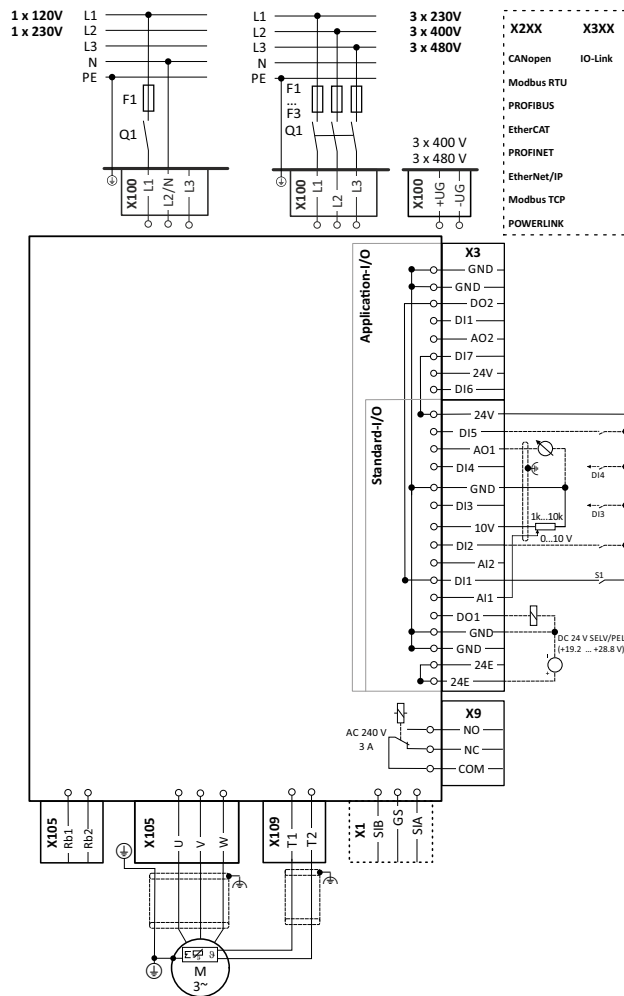

EMC-compliant installation

The drive system of inverter and drive comply with the EMC Directive 2014/30/EU if they are installed according to the specifications of CE-typical drive systems. These guidelines should also be followed in installations requiring FCC Part 15 or ICES 001 compliance. The structure at the installation location must support the EMC-compliant installation with shielded motor cables.

- Please use sufficiently conductive shield connections.
- Connect the housing with shielding effect to the grounded mounting plate with a surface as large as possible, e.g. of inverters and RFI filters.
- Use central earthing points.

The following example shows the effective wiring.

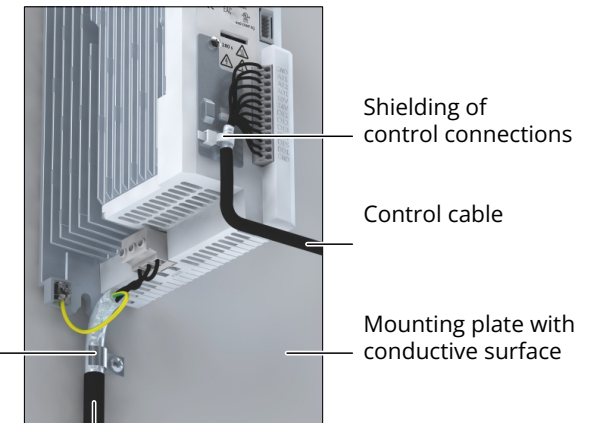

Shield connection for motor cable (alternatively: shield connection on an optional motor shield plate)

- Low-capacitance motor cable
- C-core/core/C-core/shield < 75/150 pF/m ≤ 2.5 mm² (≥ AWG 14)
- C-core/core/C-core/shield < 150/300 pF/m ≥ 4 mm² (≤ AWG 12)

Electrical installation

Preparation Connection diagram **1-phase | 120 V** 1-phase | 230/240 V 3-phase | 230/240 V 3-phase | 400 V 3-phase | 480 V Brake resistor Control terminals Relay output

PTC input Networks Functional safety Safe torque off (STO)

1-phase mains connection 120 V (90 V ... 132 V, 45 Hz ... 65 Hz)

Terminal data

Inverter		I55AExxxA			
Rated power	kW	0.25 ... 0.37		0.75 ... 1.1	
Connection		Mains connection X100		PE connection	
Connection type		Screw terminal		Screw	
Max. cable cross-section	mm ²	2.5		6	
Stripping length	mm	8		10	
Tightening torque	Nm	0.5		2	
Required tool		⊖ 0.5 x 3.0		⊕ TX20	

Rated data and fusing data

Inverter		I55AE			
		125A	137A	175A	211A
Rated power	kW	0.25	0.37	0.75	1.1
Rated output current (8 kHz)	A	1.7	2.4	4.2	6
Max output current (≤ 8 kHz) *	A	3.4	4.8	8.4	12
Operation without mains choke					
Rated mains current	A	6.8	9.6	16.8	22.9
Fuse (EN 60204-1)					
Characteristic					
Max. rated current	A	16	16	32	32
Max. short-circuit current (SCCR)	kA	5	5	5	5
Circuit breaker (EN 60204-1)					
Characteristic					
Max. rated current	A	16	16	32	32
Max. short-circuit current (SCCR)	kA	5	5	5	5
Residual current device (RCD)					
≥ 30 mA, type B					

* Overload time = 3 s, recovery time = 12 s

Electrical installation

- Preparation
- Connection diagram
- 1-phase | 120 V
- 1-phase | 230/240 V
- 3-phase | 230/240 V
- 3-phase | 400 V
- 3-phase | 480 V
- Brake resistor
- Control terminals
- Relay output
- PTC input
- Networks
- Functional safety
- Safe torque off (STO)

1-phase mains connection 230/240 V (170 V ... 264 V, 45 Hz ... 65 Hz)

Terminal data

Inverter		I55AExxxB (1-phase), I55AExxD (1/3-phase)			
Rated power	kW	0.25 ... 0.75		1.1 ... 2.2	
Connection		Mains connection X100		PE connection	
Connection type		Screw terminal		Screw	
Max. cable cross-section	mm ²	2.5		6	
Stripping length	mm	8		10	
Tightening torque	Nm	0.5		0.7	
Required tool		⊖ 0.5 x 3.0		⊖ 0.6 x 3.5	
				⊕ TX20	
				⊖ 0.5 x 3.0	

Rated data and fusing data

Inverter		I55AE													
		125B	125D	137B	137D	155B	155D	175B	175D	211B	211D	215B	215D	222B	222D
Rated power	kW	0.25		0.37		0.55		0.75		1.1		1.5		2.2	
Rated output current (8 kHz)	A	1.7		2.4		3.2		4.2		6		7		9.6	
Max output current (≤ 8 kHz) *	A	3.4		4.8		6.4		8.4		12		14		19.2	
Operation without mains choke															
Rated mains current	A	4		5.7		7.6		10		14.3		16.7		22.5	
Fuse (EN 60204-1)															
Characteristic		gG/gL or gRL													
Max. rated current	A	16		16		16		16		32		32		32	
Max. short-circuit current (SCCR)	kA	65		65		65		65		65		65		65	
Circuit breaker (EN 60204-1)															
Characteristic		B, C													
Max. rated current	A	16		16		16		16		32		32		32	
Max. short-circuit current (SCCR)	kA	65		65		65		65		65		65		65	
Residual current device (RCD)		≥ 30 mA, type B, F **													

* Overload time = 3 s, recovery time = 12 s

** RCD type "F" is only permitted in 1-phase operation (L/N)!

Electrical installation

- Preparation
- Connection diagram
- 1-phase | 120 V
- 1-phase | 230/240 V
- 3-phase | 230/240 V
- 3-phase | 400 V
- 3-phase | 480 V
- Brake resistor
- Control terminals
- Relay output
- PTC input
- Networks
- Functional safety
- Safe torque off (STO)

3-phase mains connection 230/240 V (195 V ... 264 V, 45 Hz ... 65 Hz)

Terminal data

Inverter		I55AExxD (1/3-phase), I55AExxC (3-phase)					
Rated power	kW	0.25 ... 0.75	1.1 ... 2.2	4 ... 5.5	0.25 ... 5.5	0.25 ... 2.2	4 ... 5.5
Connection		Mains connection X100			PE connection		Motor connection X105
Connection type		Screw terminal			Screw		Screw terminal
Max. cable cross-section	mm ²	2.5	6	6	6	2.5	6
Stripping length	mm	8	8	9	10	8	9
Tightening torque	Nm	0.5	0.7	0.5	2	0.5	0.5
Required tool		⊖ 0.5 x 3.0	⊖ 0.6 x 3.5	⊖ 0.6 x 3.5	⊕ TX20	⊖ 0.5 x 3.0	⊖ 0.6 x 3.5

Rated data (Heavy Duty) und fusing data

Inverter		I55AE									
		125D	137D	155D	175D	211D	215D	222D	240C	255C	
Rated power	kW	0.25	0.37	0.55	0.75	1.1	1.5	2.2	4	5.5	
Rated output current (8 kHz)	A	1.7	2.4	3.2	4.2	6	7	9.6	16.5	23	
Max output current (≤ 8 kHz) *	A	3.4	4.8	6.4	8.4	12	14	19.2	33	46	
Operation without mains choke											
Rated mains current	A	2.6	3.9	4.8	6.4	7.8	9.5	13.6	20.6	28.8	
Fuse (EN 60204-1)											
Characteristic		gG/gL or gRL									
Max. rated current	A	16	16	16	16	32	32	32	40	40	
Max. short circuit current (SCCR)	kA	65	65	65	65	65	65	65	65	65	
Circuit breaker (EN 60204-1)											
Characteristic		B, C									
Max. rated current	A	16	16	16	16	32	32	32	40	40	
Max. short circuit current (SCCR)	kA	65	65	65	65	65	65	65	65	65	
Residual current device (RCD)		≥ 30 mA, type B, F **							≥ 300 mA, type B		

Rated data (light duty)

Inverter		I55AE								
		125D	137D	155D	175D	211D	215D	222D	240C	255C
Rated power	kW	-	-	-	-	-	-	-	5.5	7.5
Rated output current (4 kHz)	A	-	-	-	-	-	-	-	20.6	27.6
Max. output current *	A	-	-	-	-	-	-	-	33	46

* Overload time = 3 s, recovery time = 12 s

** RCD type "F" is only permitted in 1-phase operation (L/N)!

Electrical installation

- Preparation
- Connection diagram
- 1-phase | 120 V
- 1-phase | 230/240 V
- 3-phase | 230/240 V
- 3-phase | 400 V**
- 3-phase | 480 V
- Brake resistor
- Control terminals
- Relay output
- PTC input
- Networks
- Functional safety
- Safe torque off (STO)

3-phase mains connection 400 V (340 V ... 528 V, 45 Hz ... 65 Hz)

Terminal data

Inverter		I55AExxxF		I55BExxxF	I55xExxxF	I55AExxxF		I55BExxxF
Rated power	kW	0.37 ... 2.2	3 ... 5.5	3 ... 4	0.37 ... 5.5	0.37 ... 2.2	3 ... 5.5	3 ... 4
Connection		Mains connection X100			PE connection	Motor connection X105		
Connection type		Screw terminal			Screw	Screw terminal		
Max. cable cross-section	mm ²	2.5	6	4	6	2.5	6	2.5
Stripping length	mm	8	9	8	10	8	9	8
Tightening torque	Nm	0.5	0.5	0.6	2	0.5	0.5	0.5
Required tool		⊖ 0.5 x 3.0	⊖ 0.6 x 3.5	⊖ 0.5 x 3.0	⊕ TX20	⊖ 0.5 x 3.0	⊖ 0.6 x 3.5	⊖ 0.5 x 3.0

Rated data (Heavy Duty) und fusing data

Inverter		I55AE						I55AE	I55BE	I55AE	I55BE	I55AE
		137F	155F	175F	211F	215F	222F	230F	240F	255F		
Rated power	kW	0.37	0.55	0.75	1.1	1.5	2.2	3	4	5.5		
Rated output current (8 kHz)	A	1.3	1.8	2.4	3.2	3.9	5.6	7.3	9.5	13		
Max output current (≤ 8 kHz) *	A	2.6	3.6	4.8	6.4	7.8	11.2	14.6	19	26		
Operation without mains choke												
Rated mains current	A	1.8	2.5	3.3	4.4	5.4	7.8	9.6	12.5	17.2		
Fuse (EN 60204-1)												
Characteristic		gG/gL, gRL										
Max. rated current	A	16	16	16	16	16	16	25	35	25	35	25
Max. short circuit current (SCCR)	kA	65	65	65	65	65	65	65	65	65	65	65
Circuit breaker (EN 60204-1)												
Characteristic		B, C										
Max. rated current	A	16	16	16	16	16	16	25	25	25	25	25
Max. short circuit current (SCCR)	kA	65	65	65	65	65	65	65	65	65	65	65
Residual current device (RCD)		≥ 30 mA, type B										≥ 300 mA, type B

Rated data (light duty)

Inverter		I55AE						I55AE	I55BE	I55AE	I55BE	I55AE
		137F	155F	175F	211F	215F	222F	230F	240F	255F		
Rated power	kW	-	-	-	-	-	-	4	5.5	7.5		
Rated output current (4 kHz)	A	-	-	-	-	-	-	8.8	11.9	15.6		
Max. output current *	A	-	-	-	-	-	-	14.6	19	26		

* Overload time = 3 s, recovery time = 12 s



Electrical installation

- Preparation
- Connection diagram
- 1-phase | 120 V
- 1-phase | 230/240 V
- 3-phase | 230/240 V
- 3-phase | 400 V**
- 3-phase | 480 V
- Brake resistor
- Control terminals
- Relay output
- PTC input
- Networks
- Functional safety
- Safe torque off (STO)

3-phase mains connection 400 V (340 V ... 528 V, 45 Hz ... 65 Hz)

Terminal data

Inverter		I55xExxxF							
Rated power	kW	7.5 ... 11		15 ... 30		7.5 ... 11		15 ... 30	
Connection		Mains connection X100				PE connection		Motor connection X105	
Connection type		Screw terminal				Screw		Screw terminal	
Max. cable cross-section	mm ²	16		35		16		25	
Stripping length	mm	11		18		11		16	
Tightening torque	Nm	1.2		3.8		3.4		4	
Required tool		⊖ 0.8 x 4.0		⊖ 0.8 x 5.5		⊕ PZ2		⊕ PZ2	
		⊖ 0.8 x 4.0		⊖ 0.8 x 5.5		⊖ 0.8 x 4.0		⊖ 0.8 x 5.5	

Rated data (Heavy Duty) und fusing data

Inverter		I55AE		I55BE		I55AE		I55BE		I55AE		I55BE	
		275F		311F		315F		318F		322F		330F	
Rated power	kW	7.5		11		15		18.5		22		30	
Rated output current (8 kHz)	A	16.5		23.5		32		40		47		61	
Max output current (≤ 8 kHz) *	A	33		47		64		80		94		122	
Operation without mains choke													
Rated mains current	A	20		28.4		38.7		48.4		-	53	-	
Fuse (EN 60204-1)		gG/gL, gRL											
Characteristic													
Max. rated current	A	40	40	40	40	63	90	63	90	63	90	125	90
Max. short circuit current (SCCR)	kA	65	65	65	65	65	65	65	65	65	65	22	65
Circuit breaker (EN 60204-1)		B, C											
Characteristic													
Max. rated current	A	40	40	40	40	63	90	63	90	63	90	125	90
Max. short circuit current (SCCR)	kA	65	65	65	65	65	65	65	65	65	65	35	65
Residual current device (RCD)		≥ 300 mA, type B		≥ 30 mA, type B		≥ 300 mA, type B		≥ 30 mA, type B		≥ 300 mA, type B			

Rated data (light duty)

Inverter		I55AE		I55BE		I55AE		I55BE		I55AE		I55BE	
		275F		311F		315F		318F		322F		330F	
Rated power	kW	11		15		18.5		22		30		37	
Rated output current (4 kHz)	A	23		28.2		38.4		48		56.4		73.2	
Max. output current *	A	33		47		64		80		94		122	

* Overload time = 3 s, recovery time = 12 s



Electrical installation

- Preparation
- Connection diagram
- 1-phase | 120 V
- 1-phase | 230/240 V
- 3-phase | 230/240 V
- 3-phase | 400 V**
- 3-phase | 480 V
- Brake resistor
- Control terminals
- Relay output
- PTC input
- Networks
- Functional safety
- Safe torque off (STO)

3-phase mains connection 400 V (340 V ... 528 V, 45 Hz ... 65 Hz)

Terminal data

Inverter		I55xExxxF								
Rated power	kW	37 ... 45	55 ... 75	90 ... 110	37 ... 75	90 ... 110	37 ... 45	55 ... 75	90 ... 110	
Connection		Mains connection X100			PE connection		Motor connection X105			
Connection type		Screw terminal			Screw	Bolt	Screw terminal			
Max. cable cross-section	mm ²	50	95	150	35	150	50	95	150	
Stripping length	mm	22	32	41	16	-	22	32	41	
Tightening torque	Nm	4	10	18	4	10	4	10	18	
Required tool		⊙ 5.0	⊙ 6.0	⊙ 8.0	⊕ PZ2	Size 13 key	⊙ 5.0	⊙ 6.0	⊙ 8.0	

Rated data (Heavy Duty) und fusing data

Inverter		I55AE						
		337F	345F	355F	375F	390F	411F	
Rated power	kW	37	45	55	75	90	110	
Rated output current (8 kHz)	A	76	89	110	150	180	212	
Max output current (≤ 8 kHz) *	A	152	178	220	300	360	424	
Operation without mains choke								
Rated mains current	A	-	-	-	-	-	-	
Fuse (EN 60204-1)								
Characteristic		gG/gL, gRL			gR			
Max. rated current	A	125	125	200	200	300	300	
Max. short circuit current (SCCR)	kA	22	22	22	22	22	22	
Circuit breaker (EN 60204-1)								
Characteristic		B, C						
Max. rated current	A	125	125	200	200	300	300	
Max. short circuit current (SCCR)	kA	35	35	35	35	10	10	
Residual current device (RCD)		≥ 300 mA, type B						

Rated data (light duty)

Inverter		I55AE					
		337F	345F	355F	375F	390F	411F
Rated power	kW	45	55	75	90	110	132
Rated output current (4 kHz)	A	91.2	107	132	180	216	254
Max. output current *	A	152	178	220	300	360	424

* Overload time = 3 s, recovery time = 12 s

Electrical installation

- Preparation
- Connection diagram
- 1-phase | 120 V
- 1-phase | 230/240 V
- 3-phase | 230/240 V
- 3-phase | 400 V
- 3-phase | 480 V**
- Brake resistor
- Control terminals
- Relay output
- PTC input
- Networks
- Functional safety
- Safe torque off (STO)

3-phase mains connection 480 V (340 V ... 528 V, 45 Hz ... 65 Hz)

Terminal data

Inverter		I55AExxxF		I55BExxxF	I55xExxxF	I55AExxxF		I55BExxxF
Rated power	kW	0.37 ... 2.2	3 ... 5.5	3 ... 4	0.37 ... 5.5	0.37 ... 2.2	3 ... 5.5	3 ... 4
Connection		Mains connection X100			PE connection	Motor connection X105		
Connection type		Screw terminal			Screw	Screw terminal		
Max. cable cross-section	mm ²	2.5	6	4	6	2.5	6	2.5
Stripping length	mm	8	9	8	10	8	9	8
Tightening torque	Nm	0.5	0.5	0.6	2	0.5	0.5	0.5
Required tool		⊖ 0.5 x 3.0	⊖ 0.6 x 3.5	⊖ 0.5 x 3.0	⊕ TX20	⊖ 0.5 x 3.0	⊖ 0.6 x 3.5	⊖ 0.5 x 3.0

Rated data (Heavy Duty) und fusing data

Inverter		I55AE						I55AE	I55BE	I55AE	I55BE	I55AE
		137F	155F	175F	211F	215F	222F	230F		240F		255F
Rated power	kW	0.37	0.55	0.75	1.1	1.5	2.2	3		4		5.5
Rated output current (8 kHz)	A	1.1	1.6	2.1	3	3.5	4.8	6.3		8.2		11
Max output current (≤ 8 kHz) *	A	2.2	3.2	4.2	6	7	9.6	12.6		16.4		22
Operation without mains choke												
Rated mains current	A	1.5	2.1	2.8	3.7	4.5	6.5	8		10.5		14.3
Fuse (EN 60204-1)												
Characteristic		gG/gL, gRL										
Max. rated current	A	16	16	16	16	16	16	25	35	25	35	25
Max. short circuit current (SCCR)	kA	65	65	65	65	65	65	65	65	65	65	65
Circuit breaker (EN 60204-1)												
Characteristic		B, C										
Max. rated current	A	16	16	16	16	16	16	25	25	25	25	25
Max. short circuit current (SCCR)	kA	65	65	65	65	65	65	65	65	65	65	65
Residual current device (RCD)		≥ 30 mA, type B										
		≥ 300 mA, type B										

Rated data (light duty)

Inverter		I55AE						I55AE	I55BE	I55AE	I55BE	I55AE
		137F	155F	175F	211F	215F	222F	230F		240F		255F
Rated power	kW	-	-	-	-	-	-	4		5.5		7.5
Rated output current (4 kHz)	A	-	-	-	-	-	-	7.6		9.8		13.2
Max. output current *	A	-	-	-	-	-	-	12.6		16.4		22

* Overload time = 3 s, recovery time = 12 s

Electrical installation

- Preparation
- Connection diagram
- 1-phase | 120 V
- 1-phase | 230/240 V
- 3-phase | 230/240 V
- 3-phase | 400 V
- 3-phase | 480 V**
- Brake resistor
- Control terminals
- Relay output
- PTC input
- Networks
- Functional safety
- Safe torque off (STO)

3-phase mains connection 480 V (340 V ... 528 V, 45 Hz ... 65 Hz)

Terminal data

Inverter		I55xExxxF											
Rated power	kW	7.5 ... 11		15 ... 30		7.5 ... 11		15 ... 30		7.5 ... 11		15 ... 30	
Connection		Mains connection X100				PE connection				Motor connection X105			
Connection type		Screw terminal				Screw				Screw terminal			
Max. cable cross-section	mm ²	16		35		16		25		16		35	
Stripping length	mm	11		18		11		16		11		18	
Tightening torque	Nm	1.2		3.8		3.4		4		1.2		3.8	
Required tool		⊖ 0.8 x 4.0		⊖ 0.8 x 5.5		⊕ PZ2		⊕ PZ2		⊖ 0.8 x 4.0		⊖ 0.8 x 5.5	

Rated data (Heavy Duty) und fusing data

Inverter		I55AE		I55BE		I55AE		I55BE		I55AE		I55BE	
		275F		311F		315F		318F		322F		330F	
Rated power	kW	7.5		11		15		18.5		22		30	
Rated output current (8 kHz)	A	14		21		27		34		40.4		52	
Max output current (≤ 8 kHz) *	A	28		42		54		68		81		104	
Operation without mains choke													
Rated mains current	A	16.6		23.7		32.3		40.3		44.2		61.5	
Fuse (EN 60204-1)													
Characteristic		gG/gL, gRL											
Max. rated current	A	40	40	40	40	63	90	63	90	63	90	125	90
Max. short circuit current (SCCR)	kA	65	65	65	65	65	65	65	65	65	65	22	65
Circuit breaker (EN 60204-1)													
Characteristic		B, C											
Max. rated current	A	40	40	40	40	63	90	63	90	63	90	125	90
Max. short circuit current (SCCR)	kA	65	65	65	65	65	65	65	65	65	65	35	65
Residual current device (RCD)		≥ 300 mA, type B		≥ 30 mA, type B		≥ 300 mA, type B		≥ 30 mA, type B		≥ 300 mA, type B			

Rated data (light duty)

Inverter		I55AE		I55BE		I55AE		I55BE		I55AE		I55BE	
		275F		311F		315F		318F		322F		330F	
Rated power	kW	11		15		18.5		22		30		37	
Rated output current (4 kHz)	A	18.3		25.2		32.4		40.8		48.5		62.4	
Max. output current *	A	28		42		54		68		81		104	

* Overload time = 3 s, recovery time = 12 s



Electrical installation

- Preparation
- Connection diagram
- 1-phase | 120 V
- 1-phase | 230/240 V
- 3-phase | 230/240 V
- 3-phase | 480 V
- Brake resistor
- Control terminals
- Relay output
- PTC input
- Networks
- Functional safety
- Safe torque off (STO)

3-phase mains connection 480 V (340 V ... 528 V, 45 Hz ... 65 Hz)

Terminal data

Inverter		I55xExxxF								
Rated power	kW	37 ... 45	55 ... 75	90 ... 110	37 ... 75	90 ... 110	37 ... 45	55 ... 75	90 ... 110	
Connection		Mains connection X100			PE connection		Motor connection X105			
Connection type		Screw terminal			Screw	Bolt	Screw terminal			
Max. cable cross-section	mm ²	50	95	150	35	150	50	95	150	
Stripping length	mm	22	32	41	16	-	22	32	41	
Tightening torque	Nm	4	10	18	4	10	4	10	18	
Required tool		⊙ 5.0	⊙ 6.0	⊙ 8.0	⊕ PZ2	Size 13 key	⊙ 5.0	⊙ 6.0	⊙ 8.0	

Rated data (Heavy Duty) und fusing data

Inverter		I55AE						
		337F	345F	355F	375F	390F	411F	
Rated power	kW	37	45	55	75	90	110	
Rated output current (8 kHz)	A	65	77	96	124	156	180	
Max output current (≤ 8 kHz) *	A	130	154	192	248	312	360	
Operation without mains choke								
Rated mains current	A	-	-	-	-	-	-	
Fuse (EN 60204-1)								
Characteristic		gG/gL, gRL			gR			
Max. rated current	A	125	125	200	200	300	300	
Max. short circuit current (SCCR)	kA	22	22	22	22	22	22	
Circuit breaker (EN 60204-1)								
Characteristic		B, C						
Max. rated current	A	125	125	200	200	300	300	
Max. short circuit current (SCCR)	kA	35	35	35	35	10	10	
Residual current device (RCD)		≥ 300 mA, type B						

Rated data (light duty)

Inverter		I55AE					
		337F	345F	355F	375F	390F	411F
Rated power	kW	45	55	75	90	110	132
Rated output current (4 kHz)	A	78	92.4	115	149	187	216
Max. output current *	A	130	154	192	248	312	360

* Overload time = 3 s, recovery time = 12 s

Electrical installation

- Preparation
- Connection diagram
- 1-phase | 120 V
- 1-phase | 230/240 V
- 3-phase | 230/240 V
- 3-phase | 400 V
- 3-phase | 480 V
- Control terminals
- Relay output
- PTC input
- Networks
- Functional safety
- Safe torque off (STO)

Brake resistor connection

NOTICE

Overload

Possible consequences: Irreversible damage to the brake resistor

- Protect the brake resistor of the inverter against overload with suitable parameterization.
- The thermostat of the brake resistor can be used to establish a safety shutdown to disconnect the inverter from the mains.

Recommendation: Use intrinsically safe brake resistors to be able to dispense with a separate switch-off device (e.g. a contactor).

<p>Short connection cables up to 0.5 m</p> <p>Up to a cable length of 0.5 m, the cable for the brake resistor and that of the temperature monitoring can be twisted. This procedure reduces problems caused by EMC interference.</p>	<p>Long connection cables up to max. 5 m</p> <p>The cable of the brake resistor must be shielded. The maximum length is 5 m. For the temperature monitoring cable, twisting is sufficient.</p>
<p>1 Wiring to the "brake resistor" connection on the inverter or another component with brake chopper.</p>	<p>Optional: Wiring to a control contact that is set to monitor the thermal contact. If the thermal contact responds, the voltage supply to the inverter must be disconnected (e.g. switch off the control of the mains contactor).</p>

Electrical installation

Preparation Connection diagram 1-phase | 120 V 1-phase | 230/240 V 3-phase | 230/240 V 3-phase | 400 V 3-phase | 480 V Brake resistor **Control terminals** Relay output

PTC input Networks Functional safety Safe torque off (STO)

Control terminals X3

Connection type		Spring terminal, pluggable
Max. cable cross-section	mm ²	1.5
Stripping length	mm	9
Required tool		⊖ 0.4 x 2.5
Application	DI1 DI2 DI3 DI4 DI5	Digital inputs DI3/DI4 can optionally be used as frequency input or encoder input. HIGH active/LOW active switchable LOW = 0 ... +3 V HIGH = +12 V ... +30 V
	DO1	Digital output Max. 100 mA for DO1 and 24 V output
	AI1 AI2	Analog inputs Can optionally be used as voltage input or current input.
	AO1	Analog output Can be optionally used as voltage output or current output.
	24E	24-V input For mains-independent power DC supply of control electronics (including communication). Max. 1 A
	10V	10 V output Primarily for the supply of a potentiometer (1 ... 10 kΩ). Max. 10 mA
	24V	24 V output Primarily for the supply of digital inputs. Max. 100 mA for DO1 and 24 V output

NOTICE

For voltage supply with DC 24 V (± 20 %), use only a safely separated power supply unit in accordance with prevailing SELV/PELV requirements.

Electrical installation

- Preparation
- Connection diagram
- 1-phase | 120 V
- 1-phase | 230/240 V
- 3-phase | 230/240 V
- 3-phase | 400 V
- 3-phase | 480 V
- Brake resistor
- Control terminals
- Relay output
- PTC input
- Networks
- Functional safety
- Safe torque off (STO)

Relay output X9

The relay is not suitable for direct switching of an electromechanical holding brake. Use a corresponding suppressor circuit in case of an inductive or capacitive load.

Connection type		Screw terminal, pluggable
Max. cable cross-section	mm ²	1.5
Stripping length	mm	6
Required tool		⊖ 0.4 x 2.5
Application	NO	Normally-open contact
	NC	Normally-closed contact
	COM	Center contact
Max. switching voltage/switching current		AC 240 V/3 A
		DC 24 V/2 A
		DC 240 V/0.16 A

Electrical installation

Preparation Connection diagram 1-phase | 120 V 1-phase | 230/240 V 3-phase | 230/240 V 3-phase | 400 V 3-phase | 480 V Brake resistor Control terminals Relay output

PTC input Networks Functional safety Safe torque off (STO)

PTC input X109

In the default setting, the motor temperature monitoring is active! By default, a wire jumper is installed between the terminals T1 and T2. Before connecting a thermal sensor, remove the wire jumper.

Connection type		Screw terminal, pluggable
Max. cable cross-section	mm ²	1.5
Stripping length	mm	6
Required tool		⊖ 0.4 x 2.5
Application	T1 T2	Connection of PTC or thermal contact
Sensor types		PTC single sensor (DIN 44081) PTC triplet sensor (DIN 44082) Thermal contact

Electrical installation

- Preparation
- Connection diagram
- 1-phase | 120 V
- 1-phase | 230/240 V
- 3-phase | 230/240 V
- 3-phase | 400 V
- 3-phase | 480 V
- Brake resistor
- Control terminals
- Relay output
- PTC input
- Networks
- Functional safety
- Safe torque off (STO)

Networks

Network		CANopen	Modbus RTU	IO-Link	PROFIBUS	EtherCAT	EtherNet/IP	Modbus TCP	POWERLINK	PROFINET
Connection		X216		X316	X226	X246 X247	X266 X267	X276 X277	X286 X287	X256 X257
Connection type		Spring terminal, pluggable			Sub-D socket, 9-pole	RJ45	RJ45	RJ45	RJ45	RJ45
Max. cable cross-section	mm ²	2.5			-	-	-	-	-	-
Stripping length	mm	10			-	-	-	-	-	-
Required tool		⊖ 0.4 x 2.5			-	-	-	-	-	-

CANopen / Modbus RTU

The network must be terminated with a resistor at the first and last physical node. At these nodes, set the DIP switch "R" to ON.

You can use the other DIP switches to set the node address and baud rate. When these DIP switches are all in the OFF position: Node address = setting in P510.01, baud rate = setting in P510.02. For Modbus RTU, the baud rate and parity are detected automatically in OFF position.

EtherCAT

You can set the EtherCAT identifier for "Explicit Device Identification" using the rotary encoder switches. When both are in position 0: Identifier = setting in P510.04.

Ethernet/IP / Modbus TCP

You can set the last byte of the IP address using the rotary encoder switches: 192.168.124.<switch position>. When both are in position 0: IP address = setting in P510.01.

POWERLINK

The rotary encoder switches allow you to set the node address (last byte of the IP address). Resulting IP address: 192.168.100.<switch position> When both are in position 0: Node address = setting in 0x23C1:004.

PROFIBUS

The network must be terminated with a resistor at the first and last physical node. Activate the bus terminating resistor in the bus connector at these nodes.

Use the DIP switches to set the station address. When all DIP switches are in OFF position: Station address = setting in P510.01, the baud rate is detected automatically.

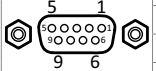
X226	Pin	Assignment	Description
	1	Shield	Additional shielding
	2	n. c.	
	3	RxD/TxD-P	Data line-B (received data/transmitted data +)
	4	RTS	Request To Send (received data/transmitted data, no differential signal)
	5	M5V2	Reference potential (bus terminating resistor -)
	6	P5V2	5 V DC / 30 mA (bus terminating resistor +, OLM, OLP)
	7	n. c.	
	8	RxD/TxD-N	Data line-A (received data/transmitted data -)
	9	n. c.	

PROFINET

The rotary encoder switches have no function.

Electrical installation

- Preparation
- Connection diagram
- 1-phase | 120 V
- 1-phase | 230/240 V
- 3-phase | 230/240 V
- 3-phase | 400 V
- 3-phase | 480 V
- Brake resistor
- Control terminals
- Relay output
- PTC input
- Networks
- Functional safety
- Safe torque off (STO)

Functional safety

⚠ DANGER!

Uncontrolled start-up

Improper installation of the safety technology can cause an uncontrolled starting action of the drives.

Possible consequences: Death or severe injuries

- Safety technology may only be installed and commissioned by qualified personnel.
- All wiring must be EMC-compliant.
- All control components (switches, relays, PLC, ...) must comply with the requirements of EN ISO 13849-1 and EN ISO 13849-2.
- Switches, relays with at least IP54 enclosure.
- Devices with a degree of protection less than IP54 must always be installed in a control cabinet with a minimum protection class of IP54.
- The wiring must be shielded.
- It is essential to use insulated wire end ferrules for wiring.
- All safety-relevant cables outside the control cabinet must be protected, e.g. by means of a cable duct.
- Securely eliminate short-circuits and crossed wires according to the specifications of EN ISO 13849-2.
- Please refer to EN ISO 13849-1 and EN ISO 13849-2 for all further requirements and measures.
- In the case of an external force effect on the drive axes, additional brakes are necessary. In particular, please observe the effect of gravitational force on hanging loads!
- For safety-related braking functions, use safety-rated brakes only.
- The user must ensure that the inverter is only operated within the specified environmental conditions in its intended application. Only by doing so can the specified safety-related characteristics be adhered to.

⚠ DANGER!

Automatic restart when the requirement of the safety function is disabled.

Possible consequences: Death or severe injuries

- You must implement external measures in accordance with EN ISO 13849-1 to ensure that the drive only starts up again after an acknowledgement.

NOTICE

Overvoltage

Possible consequences: Destruction of the safety component

- Make sure that the maximum voltage (maximum rated) at the safe inputs does not exceed 32 V DC.

NOTICE

Excessive humidity or condensation

Possible consequences: Malfunction or irreparable damage to safety component

- Only commission the safety component when it has acclimatized.

Electrical installation

- Preparation
- Connection diagram
- 1-phase | 120 V
- 1-phase | 230/240 V
- 3-phase | 230/240 V
- 3-phase | 400 V
- 3-phase | 480 V
- Brake resistor
- Control terminals
- Relay output
- PTC input
- Networks
- Functional safety
- Safe torque off (STO)**

Safe torque off (STO)

⚠ DANGER!

No "Emergency switching off" in accordance with EN 60204-1

When using the "Safe torque off (STO)" function, additional measures are required for an "Emergency switching off" in accordance with EN 60204-1. There is no electrical isolation between the motor and inverter, no service switch or repair switch!

Possible consequences: Death or severe injuries

– An "Emergency off" requires an electrical isolation, e.g. by a central mains contactor.

Control terminals X1

Connection type		Spring terminal, pluggable
Max. cable cross-section	mm ²	1.5
Stripping length	mm	9
Required tool		⊖ 0.4 x 2.5
Application	SIA SIB	Inputs for connecting active or passive sensors
	GS	Reference potential for SIA and SIB

Specifications for SIA, SIB		minimum	typical	maximum
LOW signal	V	-3	0	+5
HIGH signal	V	+15	+24	+30
Runtime	ms		3	
Switch-off time	ms		50	60
Input current SIA	mA		10	14
Input current SIB	mA		7	12
Input peak current	mA		100	
Test pulse duration	ms			1
Test pulse interval	ms	10		

Connection of active and passive sensors

The connection diagrams shown are only example circuits. The user is responsible for the correct safety-related design and selection of the components!

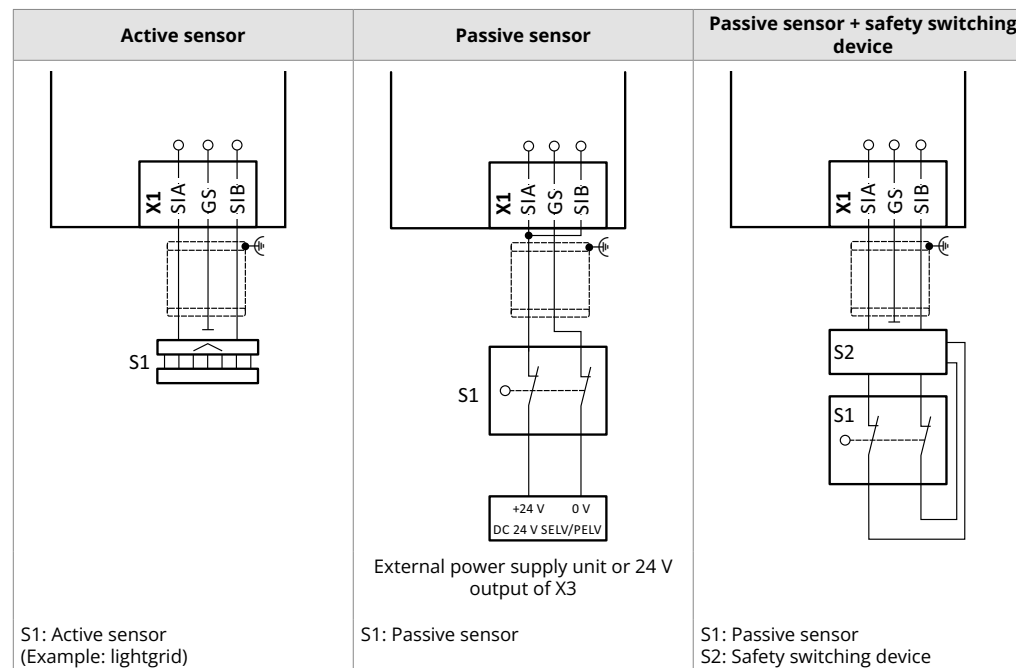

Safety-related characteristic values and further example circuits can be found in the project planning document.

Commissioning

Initial switch-on

Important notes

Keypad-module

Keypad control

Terminal control

Extended
terminal control

Parameter overview

Favorites

Basic setting

Motor control

Additional functions

Initial switch-on

**DANGER!****Unexpected states during commissioning**

Incorrect wiring can cause unexpected states during the commissioning phase.

Possible consequences: Death, severe injuries, or damage to property

- Wiring must be complete and correct.
- Wiring must be free of short circuits and earth faults.
- The motor circuit configuration (star/delta) must be adapted to the inverter.
- The motor must be connected in-phase (rotating direction).
- Check the "emergency switching off" function of the overall system.
- Clear hazardous area.
- Observe safety instructions and safety clearances.

Preconditions:

- The power connections must be wired.
- The digital inputs X3/DI1 (start/stop), X3/DI3 (reversal) and X3/DI4 (frequency preset 20 Hz) must be wired.
- The analog input X3/AI1 must not be wired or connected to GND.

1. Switch on mains voltage.
2. Check readiness for operation.
3. Observe LED status displays "RDY" and "ERR" on the inverter front panel.

Commissioning

Initial switch-on

Important notes

Keypad-module

Keypad control

Terminal control

Extended
terminal control

Parameter overview

Favorites

Basic setting

Motor control

Additional functions

Important notes

**DANGER!****Unexpected and dangerous motor movements and system movements**

Incorrect settings during commissioning may cause unexpected and dangerous motor and system movements.

Possible consequences: Death, severe injuries, or damage to property

- Clear hazardous area.
- Observe safety instructions and safety clearances.

The following plug-on modules are available as accessories for the inverter:

- Keypad module
- WLAN module
- USB module

Keypad module

Commissioning with the keypad module is described on the following pages.

WLAN module

A connection to the WLAN module is established upon entering the connection data.

Default setting:

- IP address: 192.168.178.1
- SSID: "Product type"_"10-digit identification"
- WLAN password: password

Engineering Tool »EASY Starter«

Commissioning and diagnostics can be carried out with the »EASY Starter« engineering tool. For communication, a USB module on the inverter and a standard USB cable (A plug to micro B plug) is required.

SMART Keypad App

The Lenze SMART Keypad App for Android or iOS allows you to diagnose and parameterize an inverter. A WLAN module on the inverter is required for communication.

- Ideal for the parameterization of simple applications such as a conveyor belt.
- Ideal for the diagnostics of the inverter.

The app can be found in the Google Play Store or in the Apple App Store.



Android



iOS

Commissioning

Initial switch-on

Important notes

Keypad-module

Keypad control

Terminal control

Extended terminal control

Parameter overview









Favorites

Basic setting

Motor control

Additional functions

Keypad module – Functions of the keys

Key	Actuation	Action
 Up arrow key  Down arrow key	press briefly	<ul style="list-style-type: none"> Navigation in the menu Parameter alteration
 Enter key	press briefly	<ul style="list-style-type: none"> Go to Menu/Parameter Confirm parameter
	press and hold for 3s	Save parameter ("P.SAVED" appears on screen when parameter is saved.)
 Back key	press briefly	Quit Menu/Parameters
 CTRL	press briefly	Activate keypad control
 Start key	press briefly	Start motor
 R/F key	press briefly	Reverse rotating direction
 Stop key	press briefly	Stop motor

- The motor must be at standstill before parameters can be changed or confirmed.
- The settings are saved temporarily until the motor is switched off again. Press and hold the enter key for 3 s to save the settings permanently.

Example of the keypad handling

Function assignment for digital output DO1 with parameter P420.02:

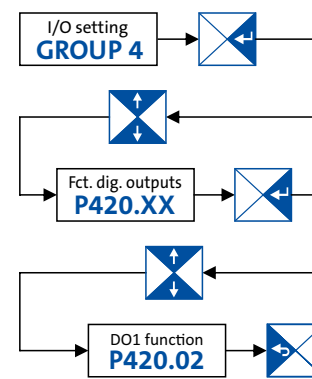

Commissioning

Initial switch-on

Important notes

Keypad module

Keypad control

Terminal control

Extended terminal control

Parameter overview

Favorites

Basic setting

Motor control

Additional functions

**Keypad control**

Activate temporary keypad control:

1. Press the CTRL key to activate the keypad control.
2. Press the enter key to confirm the change.

Deactivate temporary keypad control:

1. Press the CTRL key to deactivate the keypad control.
2. Press the enter key to confirm the change.

Activate permanent keypad control:

If the keypad does not have a CTRL key, the motor control is activated via the following parameters:

- Set P200.00 to 1.
- Set P201.01 to 1.
- Set P400.01 to 1.
- Set P400.02 to 1.

Start/control/stop motor with keypad:

1. Press the start key to start the motor.
 - The keypad shows the motor speed.
2. Change the frequency setpoint using the up arrow key or the down arrow key.
3. Press the stop key to stop the motor.

Reverse rotating direction:

1. Press the R/F key.
2. Press the enter key to confirm the reversal of rotating direction.

Commissioning

- Initial switch-on
 - Important notes
 - Keypad-module
 - Keypad control
 - Terminal control
 - Extended terminal control
 - Parameter overview
 - Favorites
 - Basic setting
 - Motor control
- Additional functions

Quick commissioning – terminal control

The following quick overview with graphical parameter representation is sufficient for commissioning many applications with terminal control. Further setting options are described in this document or in the commissioning document.

1. Load default setting: Set P700.01 to 1.
2. Set the following parameters for V/f characteristic control:
 - P208.01: Mains voltage
 - P303.01: V/f characteristic data: Base voltage
 - P303.02: V/f characteristic data: Base frequency
 - P210.00: Minimum frequency
 - P211.00: Maximum frequency
 - P220.00: Acceleration time 1
 - P221.00: Deceleration time 1
 - P430.02: Analog input 1: Min frequency value
 - P430.03: Analog input 1: Max. frequency value

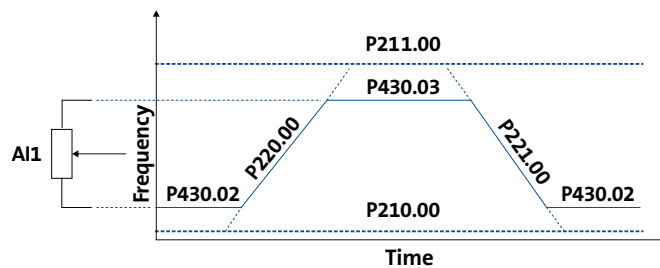

3. Save settings: Press and hold the enter key for 3 s.
4. With the wiring shown on the right, the inverter can be operated using the control terminals.

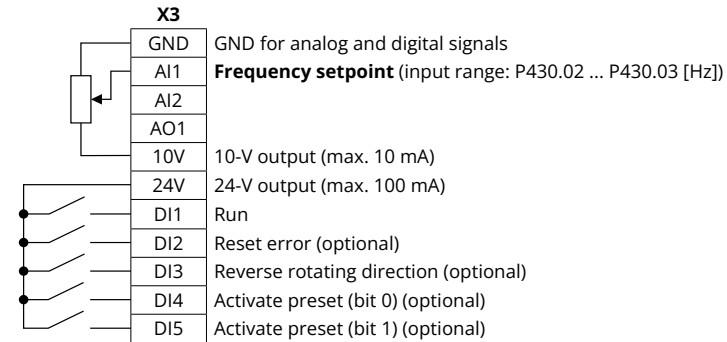

Preset 1 is activated if DI4 is connected.

Preset 2 is activated if DI5 is connected.

Preset 3 is activated if DI4 and DI5 are connected at the same time.

Commissioning

Initial switch-on

Important notes

Keypad-module

Keypad control

Terminal control

Extended terminal control

Parameter overview

Favorites

Basic setting

Motor control

Additional functions

Extended terminal control

The following illustration shows a more extensive wiring of the control terminals linked with the respective parameters.

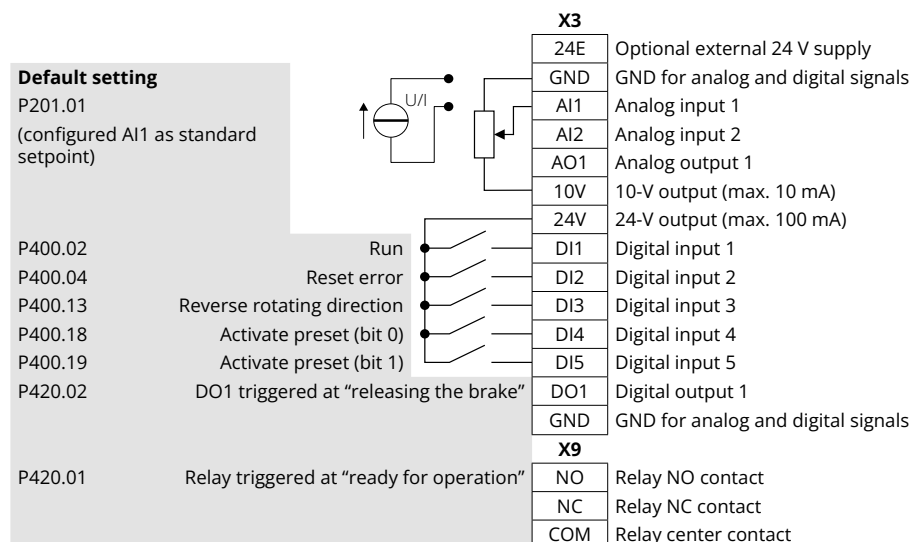

Setpoint selection and configuration:

DI5	DI4	Setpoint	Configuration	Default setting	
0	0	Analog input 1	P430.01	AI1 input area	0 ... 10 VDC
			P430.02	AI1 freq @ min	0.0 Hz
			P430.03	AI1 freq @ max	50.0 Hz / 60.0 Hz*
0	1	Preset value 1	P450.01	Freq. preset 1	20.0 Hz
1	0	Preset value 2	P450.02	Freq. preset 2	40.0 Hz
1	1	Preset value 3	P450.03	Freq. preset 3	50.0 Hz / 60.0 Hz*

* Depending on whether device is for 50-Hz mains or 60-Hz mains

Commissioning

Initial switch-on

Important notes

Keypad-module

Keypad control

Terminal control

Extended
terminal control

Parameter overview

Favorites

Basic setting

Motor control

Additional functions

**The most important parameters at a glance**

This chapter contains the most important parameters and selections.

You can find a detailed description in the commissioning document:

www.lenze.com/product-information



The parameters are divided into the following function groups:

- Pxxx.xx group 0: Favorites
- P1xx.xx group 1: Diagnostics
- P2xx.xx group 2: Basic setting
- P3xx.xx group 3: Motor control
- P4xx.xx group 4: I/O setting
- P5xx.xx group 5: Network setting
- P6xx.xx group 6: Process controller
- P7xx.xx group 7: Additional functions
- P8xx.xx group 8: Sequencer

**Favorites (group 0)**

Group 0 contains the configurable favorites that are also contained in the groups 1 to 4. In the default setting these are the most common parameters for the solution of typical applications.

Commissioning

Initial switch-on

Important notes

Keypad-module

Keypad control

Terminal control

Extended terminal control

Parameter overview

Favorites

Basic setting

Motor control

Additional functions

Favorites (group 0)

Display code	Name	Possible settings/ Value ranges	Keypad code	Information
P100.00	Output frequency	x.x Hz (read only)		Display of the actual output frequency.
P103.00	Actual current	x.x % (read only)		Display of the actual motor current.
P106.00	Motor voltage	x VAC (read only)		Display of the actual motor voltage.
P150.00	Error code	- (Read only)		Error message.
P200.00	Control selection	Flexible I/O	[0]	This selection enables a flexible assignment of the start, stop, and rotating direction commands with digital signal sources.
		Keypad	[1]	This selection enables the motor to start exclusively via the start key of the keypad. Other signal sources for starting the motor are ignored.
P201.01	F-setp.source	Keypad	[1]	The setpoint is specified locally by the keypad.
		Analog input 1	[2]	The setpoint is defined as analog signal via the analog input 1.
		Analog input 2	[3]	The setpoint is defined as analog signal via the analog input 2.
		HTL input	[4]	The digital inputs DI3 and DI4 can be configured as HTL input to use an HTL encoder as setpoint encoder or define the setpoint as a reference frequency ("pulse train").
		Network	[5]	The setpoint is defined as process data object via the network.
P203.01	Start method	Frequency preset 1 ... 15	[11] ... [25]	For the setpoint selection, "preset" values can be parameterized and selected. All frequency presets are described in detail in the commissioning manual.
		Standard	[0]	After start command, the standard ramps are active.
		DC braking	[1]	After start command, the "DC braking" function is active for the time set in P704.02.
		Flying restart circuit	[2]	After the start command, the flying restart circuit is active.
		Premagnetization	[3]	After start command, the standard ramps are active and the premagnetization of the motor is activated. This reduces the motor current and smoothes the acceleration curve during the starting process (only relevant in the V/f motor control mode).
P203.03	Stop method	Coasting	[0]	The motor has no torque (coasts down to standstill).
		Standard ramp	[1]	The motor is brought to a standstill with the deceleration time 1 P221.00 (or deceleration time 2 P223.00 if activated).
		Quick stop ramp	[2]	The motor is brought to a standstill with the deceleration time (P225.00) set for the "quick stop" function.
		Switch-off positioning	[3]	Is similar to the stop method "standard ramp [1]". Depending on the actual output frequency, however, the inverter delays the beginning of the down-ramping so that the number of motor revolutions until a standstill is reached and thus the stop position is always relatively constant.
P208.01	Mains voltage	230 Veff	[0]	Selection of the mains voltage for actuating the inverter.
		400 Veff	[1]	
		480 Veff	[2]	
		120 Veff	[3]	
P210.00	Min. frequency	0.0 ... 599.0 Hz		Lower limit value for all frequency setpoints.
P211.00	Max. frequency	Device for 50-Hz mains: 50 Hz * Device for 60-Hz mains: 60 Hz *		Upper limit value for all frequency setpoints.

* Default setting dependent on the size

Commissioning

- Initial switch-on
- Important notes
- Keypad-module
- Keypad control
- Terminal control
- Extended terminal control
- Parameter overview
- Favorites**
- Basic setting
- Motor control

Additional functions

Favorites (group 0)

Display code	Name	Possible settings/ Value ranges	Keypad code	Information
P220.00	Acceleration 1	0.0 ... 5.0 ... 3600.0 s		Acceleration time 1.
P221.00	Deceleration 1	0.0 ... 5.0 ... 3600.0 s		Deceleration time 1
P300.00	Motor ctrl mode	Servo control (SC ASM)	[2]	This control mode is used for servo control of an asynchronous motor.
		Sensorless control (SL PSM)	[3]	This control mode is used for sensorless control of a synchronous motor.
		Sensorless vector control (SLVC)	[4]	This control mode is used for sensorless vector control of an asynchronous motor.
		V/f characteristic control VFC open loop	[6]	This control mode is used for the speed control of an asynchronous motor via a V/f characteristic and is the simplest control mode.
		V/f characteristic control (VFC closed loop)	[7]	The control mode is used for speed control of an asynchronous motor via a V/f characteristic with speed feedback.
P302.00	V/f characteristic shape	Sensorless control (SLSM-PSM)	[8]	This control mode is used for sensorless control of a synchronous motor.
		Linear	[0]	Linear characteristic for drives with constant load torque over the speed.
		Square-law	[1]	Square-law characteristic for drives with a square-law load torque over the speed.
P303.01	Base voltage	0 ... 230 ... 5000 V *		Linear characteristic with energy optimization in the partial load operational range.
P303.02	Base frequency	Device for 50-Hz mains: 50 Hz * Device for 60-Hz mains: 60 Hz *		Base voltage and base frequency define the V/f ratio and thus the gradient of the V/f characteristic. – The V/f base voltage is usually set to the rated motor voltage. – The V/f base frequency is usually set to the rated motor frequency.
P304.00	Limitation of rotation	Only clockwise (CW)	[0]	The motor can only rotate clockwise (CW). The transfer of negative frequency and PID setpoints to the motor control is prevented.
		Both rotating directions	[1]	Both directions of motor rotation are enabled.
P305.00	Switching frequency	8 kHz var/opt/4 *		Selection of the inverter switching frequency.
P306.01	Overload selection	Heavy duty	[0]	Load characteristic for high dynamic requirements.
		Light Duty	[1]	Load characteristic for low dynamic requirements.
P308.01	Max. load for 60s	30 ... 150 ... 200 %		Maximum permissible thermal motor utilization (max. permissible motor current for 60 seconds). With regard to rated motor current (P323.00).
P316.01	Fixed V/f boost	0.0 ... 2.5 ... 20.0 % *		Constant voltage boost for the V/f characteristic control without feedback.
P323.00	Rated. mot curr.	0.001 ... 1.700 ... 500.000 A *		Setting of the rated motor current according to motor nameplate.
P324.00	Max. current	0.0 ... 200.0 ... 3000.0 %		Maximum overload current of the inverter. With regard to rated motor current (P323.00).
P400.01	Inverter enable	TRUE	[1]	Assignment of a trigger to the "inverter enable" function. Trigger = TRUE: The inverter is enabled (unless there is another cause for inverter disable). Trigger = FALSE: The inverter is disabled. The motor has no torque and coasts.

* Default setting dependent on the size



Commissioning

Initial switch-on

Important notes

Keypad-module

Keypad control

Terminal control

Extended terminal control

Parameter overview

Favorites

Basic setting

Motor control

Additional functions

Favorites (group 0)

Display code	Name	Possible settings/ Value ranges	Keypad code	Information
P400.02	Run	Digital input 1	[11]	<p>Assignment of a trigger to the "Run" function.</p> <p>Function 1: Start / stop motor (default setting) Function 1 is active if no further start commands (start forward/start reverse) have been connected to triggers, no keypad control is active and no network control is active. Trigger = TRUE: Let motor rotate forward (CW). Trigger = FALSE: Stop motor according to stop function (P203.03).</p> <p>Function 2: Start enable/stop motor Function 2 is active if further start commands have been connected to triggers, the keypad control is active or the network control is active. Trigger = TRUE: Start commands of the active control source are enabled. Trigger = FALSE: Stop motor.</p>
P400.03	Quick stop	Not connected	[0]	<p>Assignment of a trigger to the "Activate quick stop" function. Trigger = TRUE: Activate quick stop. Quick stop ramp adjustable in P225.00. Trigger = FALSE: Deactivate quick stop</p>
P400.04	Error reset	Digital input 2	[12]	<p>Assignment of a trigger to the "Reset error" function. Trigger = FALSE > TRUE (edge): Active error is reset (acknowledged) if the error condition is not active anymore and the error is resettable. Trigger = FALSE: No action.</p>
P400.05	DC braking	Not connected	[0]	<p>Assignment of a trigger to the "Activate DC braking" function. Trigger = TRUE: Activate DC braking. Trigger = FALSE: Deactivate DC braking.</p>
P400.06	Start forward	Not connected	[0]	<p>Assignment of a trigger to the "Start forward (CW)" function. Trigger = FALSE > TRUE (edge): Let motor rotate forward. Trigger = TRUE > FALSE (edge): No action. Stop motor via P400.02 (default digital input 1).</p>
P400.07	Start reverse	Not connected	[0]	<p>Assignment of a trigger to the "Start reverse (CCW)" function. Trigger = FALSE > TRUE (edge): Let motor rotate backward. Trigger = TRUE > FALSE (edge): No action. Stop motor via P400.02 (default digital input 1).</p>
P400.08	Run forward	Not connected	[0]	<p>Assignment of a trigger to the "Run forward (CW)" function. Trigger = TRUE: Let motor rotate forward. Trigger = FALSE: Stop motor.</p>
P400.09	Run reverse	Not connected	[0]	<p>Assignment of a trigger to the "Run reverse (CCW)" function. Trigger = TRUE: Let motor rotate backward. Trigger = FALSE: Stop motor.</p>
P400.13	Reverse rot. dir.	Digital input 3	[13]	<p>Assignment of a trigger to the "Reverse rotating direction" function. Trigger = TRUE: The setpoint specified is inverted (i.e. the sign is inverted). Trigger = FALSE: No action/deactivate function again.</p>

* Default setting dependent on the size



Commissioning

- Initial switch-on
- Important notes
- Keypad-module
- Keypad control
- Terminal control
- Extended terminal control
- Parameter overview
- Favorites**
- Basic setting
- Motor control

Additional functions

Favorites (group 0)

Display code	Name	Possible settings/ Value ranges	Keypad code	Information
P400.18	Setp: Preset B0	Digital input 4	[14]	Assignment of a trigger to the "Activate preset (bit 0)" function. Bit with the valency 2 ⁰ for the bit-coded selection and activation of a parameterized setpoint (preset value). Trigger = FALSE: Bit = "0". Trigger = TRUE: Bit = "1".
P400.19	Setp: Preset B1	Digital input 5	[15]	Assignment of a trigger to the "Activate preset (bit 1)" function. Bit with the valency 2 ¹ for the bit-coded selection and activation of a parameterized setpoint (preset value). Trigger = FALSE: Bit = "0". Trigger = TRUE: Bit = "1".
P400.20	Setp: Preset B2	Not connected	[0]	Assignment of a trigger to the "Activate preset (bit 2)" function. Bit with the valency 2 ² for the bit-coded selection and activation of a parameterized setpoint (preset value). Trigger = FALSE: Bit = "0". Trigger = TRUE: Bit = "1".
P420.01	Relay function	Running	[50]	TRUE if inverter and start are enabled and output frequency > 0.2 Hz. Otherwise FALSE.
		Ready for operation	[51]	TRUE if inverter is ready for operation (no error active, no STO active and DC-bus voltage ok). Otherwise FALSE.
		Operation enabled	[52]	TRUE if inverter and start are enabled. Otherwise FALSE.
		Stop active	[53]	TRUE if inverter is enabled and motor is not started and output frequency = 0.
		Error active	[56]	TRUE if error is active. Otherwise FALSE.
P420.02	DO1 function	Release brake	[115]	Assignment of a trigger to digital output 1. Trigger = FALSE: X3/DO1 set to LOW level. Trigger = TRUE: X3/DO1 set to HIGH level.
P430.01	AI1 input area	0 ... 10 VDC	[0]	Definition of the input range for analog input AI1.
		0 ... 5 VDC	[1]	
		2 ... 10 VDC	[2]	
		-10 ... +10 VDC	[3]	
		4 ... 20 mA	[4]	
P430.02	AI1 freq @ min	0 ... 20 mA	[5]	Scaling of the input signal AI1 to the frequency value. – Direction of rotation according to sign. – The standard setpoint source for operating mode "MS: Velocity mode" is selected in P201.01.
		-1000.0 ... 0.0 ... 1000.0 Hz		
P430.03	AI1 freq @ max	-1000.0 ... 50.0 60.0 ... 1000.0 Hz *		
P440.01	AO1 output area	Disabled	[0]	Definition of the output range for analog output AO1.
		0 ... 10 VDC	[1]	
		0 ... 5 VDC	[2]	
		2 ... 10 VDC	[3]	
		4 ... 20 mA	[4]	
		0 ... 20 mA	[5]	

* Default setting dependent on the size



Commissioning

Initial switch-on

Important notes

Keypad-module

Keypad control

Terminal control

Extended terminal control

Parameter overview

Favorites

Basic setting

Motor control

Additional functions

Favorites (group 0)

Display code	Name	Possible settings/ Value ranges	Keypad code	Information
P440.02	AO1 function	Output frequency	[1]	Current output frequency (resolution: 0.1 Hz).
		Frequency setpoint	[2]	Current frequency setpoint (resolution: 0.1 Hz).
		Analog input 1	[3]	Input signal of analog input 1 (resolution: 0.1 %).
P440.03	AO1 min. signal	-2147483648 ... 0 ... 2147483647		Definition of the signal value that corresponds to the minimum value at analog output 1.
P440.04	AO1 max. signal	-2147483648 ... 1000 ... 2147483647		Definition of the signal value that corresponds to the maximum value at analog output 1.
P450.01	Freq. preset 1	0.0 ... 20.0 ... 599.0 Hz		Parameterizable frequency setpoints (preset 1).
P450.02	Freq. preset 2	0.0 ... 40.0 ... 599.0 Hz		Parameterizable frequency setpoints (preset 2).
P450.03	Freq. preset 3	0.0 ... 50.0 60.0 ... 599.0 Hz *		Parameterizable frequency setpoints (preset 3).
P450.04	Freq. preset 4	0.0 ... 0.0 ... 599.0 Hz		Parameterizable frequency setpoints (preset 4).

* Default setting dependent on the size

Commissioning

Initial switch-on

Important notes

Keypad-module

Keypad control

Terminal control

Extended terminal control

Parameter overview

Favorites

Basic setting

Motor control

Additional functions

Basic setting (group 2)

Display code	Name	Possible settings	Keypad code	Information
P225.00	QSP del.time	1.0 s		"Quick stop deceleration time for "MS: Velocity mode" – If the "Quick stop" function is activated, the motor is brought to a standstill within the deceleration time set here. – The braking deceleration time set refers to the deceleration from the maximum frequency set (P211.00) to standstill. In the case of a lower actual frequency, the actual deceleration time is reduced accordingly. – Setting is not effective in the operating mode P301.00 = "CiA: Velocity mode [2]".

Commissioning

Initial switch-on

Important notes

Keypad-module

Keypad control

Terminal control

Extended terminal control

Parameter overview

Favorites

Basic setting

Motor control

Additional functions

Motor control (group 3)

Display code	Name	Possible settings	Keypad code	Information	
P320.04	Rated torque	50 ... 50000 rpm		General motor data. Carry out settings as specified by motor nameplate data. Note! When you enter the motor nameplate data, take into account the phase connection implemented for the motor (star or delta connection). Only enter the data applying to the connection type selected.	
P320.05	Rated frequency	1.0 ... 10000.0 Hz			
P320.06	Rated power	0.00 ... 655.35 kW 0.00 ... 878.84 hp			
P320.07	Rated voltage	0 ... 65535 V			
P320.08	Cos phi	0.00 ... 1.00			
P327.04	Mot. identif.	0 ... 1			1 = start automatic identification of the motor data. – Inverter characteristics, motor equivalent circuit diagram data and controller settings are identified and set automatically. – During the procedure, the motor is energized!
P327.05	Mot. calibrate	0 ... 1			1 = start automatic calibration of the motor data. – A default inverter characteristic is loaded. – The motor equivalent circuit diagram data and controller settings are calculated on the basis of the currently set rated motor data. – The motor is not energized.

Commissioning

Initial switch-on

Important notes

Keypad-module

Keypad control

Terminal control

Extended terminal control

Parameter overview

Favorites

Basic setting

Motor control

Additional functions

Additional functions (group 7)

Display code	Name	Possible settings	Keypad code	Information
P700.01	Load default settings	On / start	[1]	1 = reset all parameters in the RAM memory of the inverter to the default setting stored in the inverter firmware. – All parameter changes made by the user are lost during this process! – This process may take some seconds. When the device command has been executed successfully, the value 0 is shown. – Loading parameters has a direct effect on cyclic communication: The data exchange for control is interrupted and a communication error is generated.
		Off/ready	[0]	Only status feedback
P700.03	Save user data	On / start	[1]	1 = save current parameter settings in the user memory of the memory module with mains failure protection. – This process may take some seconds. When the device command has been executed successfully, the value 0 is shown. – Do not switch off the supply voltage during the saving process and do not unplug the memory module from the inverter! – When the inverter is switched on, all parameters are automatically loaded from the user memory of the memory module to the RAM memory of the inverter.
		Off/ready	[0]	Only status feedback

Troubleshooting

Error message

Error codes

Status LEDs

Support

Error message

If an error is pending, the keypad shows the following information.

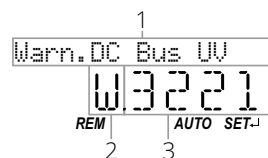

1 = Error text

2 = Error type (F = fault, T = trouble, W = warning)

3 = Error code (hexadecimal)

- Faults (F) and trouble (T) are displayed continuously. The inverter is disabled.
- Warnings (W) are displayed every 2 seconds for a short time. The inverter is probably disabled.

Reset error via keypad

Errors can be reset via the stop key.

- Prerequisite: Cause of error has been eliminated and no blocking time is active.
- Press the stop key to reset the error. The motor is stopped.
- Press the start key to cancel the stop.

Reset error via terminal control

When terminal control is used, errors can be reset in two ways:

1. Via start signal P400.02 (default setting of digital input 1).
 - Prerequisite: Cause of error has been eliminated and no blocking time is active.
 - The signal at the digital input 1 must drop and then be applied again.
2. Via error reset signal (P400.04, default setting of digital input 2).
 - Prerequisite: Cause of error has been eliminated and no blocking time is active.
 - The error is reset if a signal is applied to digital input 2.

Troubleshooting

Error message

Error codes

Status LEDs

Support

Error codes

Error code	Description	Classification	Remedy	Blocking time [s]
2250	CiA: Continuous overcurrent (inside the device)	Error	<ul style="list-style-type: none"> – Check motor and wiring for short circuits. – Check brake resistor and wiring. – Check motor circuit (delta connection, star connection). – Check setting of the motor data. 	5
2320	Short circuit or earth leakage on motor side	Error	<ul style="list-style-type: none"> – Check motor cable. – Check the length of the motor cable. – Use shorter or lower-capacitance motor cable. 	5
2340	CiA: Short circuit (inside the device)	Error	<ul style="list-style-type: none"> – Check motor cable for short circuit. 	5
2350	CiA: $i^2 \cdot t$ overload (thermal state)	Error	<ul style="list-style-type: none"> – Check drive sizing. – Check machine/driven mechanics for excessive load. – Check setting of the motor data. – Reduce values for slip compensation (P315.01, P315.02) and oscillation damping (P318.01, P318.02). 	5
2382	Error: Device utilization (Ixt) too high	Error	<ul style="list-style-type: none"> – Check drive sizing. – Reduce maximum overload current of the inverter (P324.00). – In case of high mass inertias, reduce maximum overload current of the inverter (P324.00) to 150 %. 	3
2383	Warning: Device utilization (Ixt) too high	Warning	<ul style="list-style-type: none"> – Check drive sizing. 	0
3120	Mains phase fault	Error	<ul style="list-style-type: none"> – Check mains connection wiring. – Check fuses. 	0
3210	DC-bus overvoltage	Error	<ul style="list-style-type: none"> – Reduce dynamic performance of the load profile. – Check mains voltage. – Check settings for the brake energy management. 	0
3211	Warning: DC-bus overvoltage	Warning	<ul style="list-style-type: none"> – Connect brake resistor to the power unit and activate the integrated brake chopper. (P706.01 = 0: brake resistance) 	0
3220	DC bus undervoltage	Trouble	<ul style="list-style-type: none"> – Check mains voltage. – Check fuses. 	0
3221	Warning: DC bus undervoltage	Warning	<ul style="list-style-type: none"> – Check DC-bus voltage (P105.00). – Check mains settings. 	0
3222	DC-bus voltage too low for switch-on	Warning	<ul style="list-style-type: none"> – Check mains voltage. – Check fuses. – Check mains settings. 	0
4210	PU: Overtemperature fault	Error	<ul style="list-style-type: none"> – Check mains voltage. – Provide for a sufficient cooling of the device (display of the heatsink temperature in P117.01). – Clean fan and ventilation slots. If required, replace fan. – Reduce switching frequency (P305.00). 	0
4281	Heatsink fan warning	Warning	<ul style="list-style-type: none"> – Clean fan and ventilation slots. If required, replace fan. The fans can be unlocked via locking hooks and can then be removed. 	0
4310	Error: Motor overtemperature	Error	<ul style="list-style-type: none"> – Check drive sizing. – Check motor temperature sensor and wiring (terminals X109/T1 and X109/T2). 	5
5112	24 V supply critical	Warning	<ul style="list-style-type: none"> – Check optional external 24 V voltage supply (terminal X3/24E), if connected. – Check mains voltage. 	0

Troubleshooting

Error message

Error codes

Status LEDs

Support

Error codes

Error code	Description	Classification	Remedy	Blocking time [s]
5180	24 V supply overload	Warning	– Check 24 V output and digital outputs for earth fault or overload.	0
6280	Trigger/functions connected incorrectly	Trouble	– Check and correct the assignment of the triggers to the functions. – With keypad or network control, the two functions “Inverter enable” (P400.01) and “Run” (P400.02) can also be set to “Constant TRUE [1]” to start the motor.	0
7180	Motor overcurrent	Error	– Check motor load. – Check drive sizing. – Adapt the set error threshold (P353.01).	1
9080	Keypad removed	Error	– Connect the keypad again or activate another control source.	0
FF02	Error: Brake resistor overload	Error	– Check drive sizing. – Check settings for the brake energy management. – Note! The error will be reset if the thermal load falls below the error threshold (P707.09) of - 20 %.	5
FF06	Motor overspeed	Error	– Adapt the maximum motor speed (P322.00) and the error threshold (P350.01).	1
FF36	Warning: Brake resistor overload	Warning	– Check drive dimensions. – Check settings for the brake energy management. – Note! The warning will be reset if the thermal load falls below the warning threshold (P707.08) of - 20 %.	0
FF37	Automatic start disabled	Error	– Deactivate start command and reset error.	0
FF85	Keypad full control active	Warning	– Press the CTRL key to exit control mode.	0

Troubleshooting

Error message











Error codes

Status LEDs

Support

Status LEDs

Meaning of the status LEDs for the inverter:

LED "RDY" (blue)	LED "ERR" (red)	State/meaning
off	off	No supply voltage
		Mains voltage is switched on, inverter initialized
 blinking	off	Safe torque off (STO) active. The inverter has been disabled by the integrated functional safety.
	 blinking fast	Safe torque off (STO) active, warning present. The inverter has been disabled by the integrated functional safety.
	off	Inverter disabled
 blinking	 blinking fast	Inverter disabled, warning active.
		Inverter disabled, error active.
	 on briefly every 1.5 s	Inverter disabled, no DC-bus voltage.
	off	Inverter enabled. The motor rotates according to the specified setpoint or quick stop active.
	 blinking fast	Inverter enabled, warning active. The motor rotates according to the specified setpoint or quick stop active.
	 blinking	Inverter enabled, quick stop active as response to a fault.

Troubleshooting

Error message

Error codes

Status LEDs

Support



Support

Further information can be found on the online page

www.lenze.com/product-information



The material number of the product can be found on the nameplate.

Disposal

Disposal



If pollutants are disposed off improperly, they may cause a lasting damage to human health and the environment. Thus, electrical and electronic equipment must be collected separately from unsorted municipal waste so that it may be recycled or disposed of properly. If available, put the components to the company internal disposal from where it is passed on to specialized waste management companies. It is also possible to return the components to the manufacturer. For this purpose, please contact the customer service of the manufacturer. More detailed information on disposal can be obtained from the corresponding specialist firms and the competent authorities. The packaging of the component must be disposed of separately. Paper, cardboard and plastics must be recycled.