

User Manual

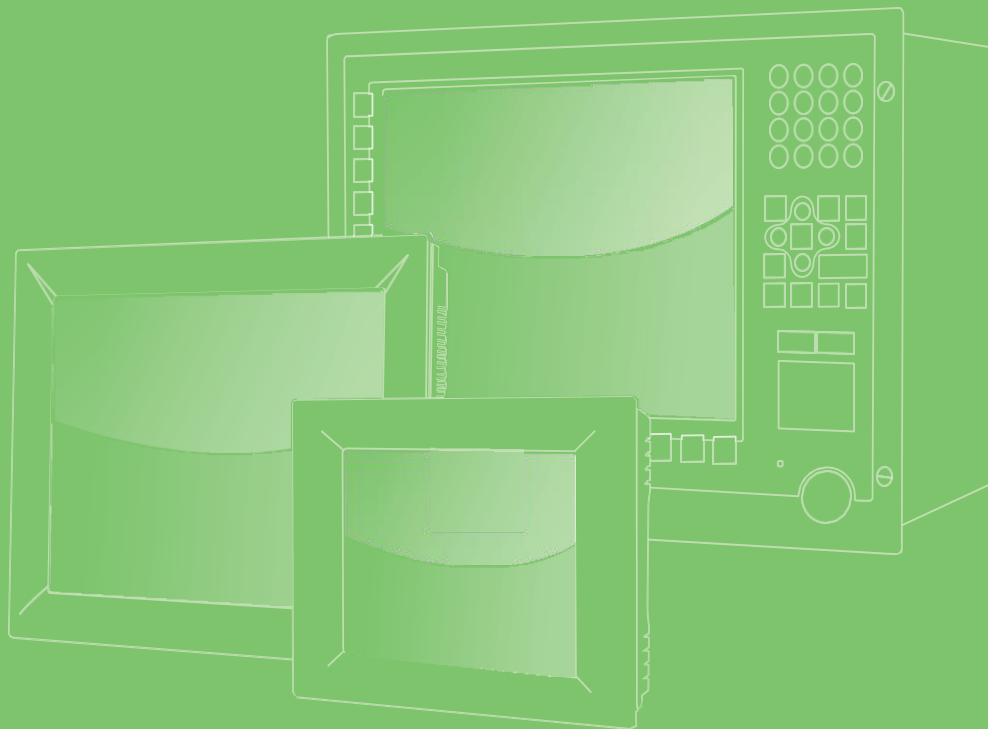

PPC-315SW/318SW/321SW ADL_N

15.6"/18.5"/21.5" Fanless Wide-
screen Panel PC with Intel® N97
Quad-Core Processor

製造商: 研華股份有限公司

地址: 台北市內湖區陽光街365巷33號

電話: 02-27927818

ADVANTECH

Enabling an Intelligent Planet

Copyright

The documentation and the software included with this product are copyrighted 2023 by Advantech Co., Ltd. All rights are reserved. Advantech Co., Ltd. reserves the right to make improvements to the products described in this manual at any time without notice. No part of this manual may be reproduced, copied, translated or transmitted in any form or by any means without the prior written permission of Advantech Co., Ltd. Information provided in this manual is intended to be accurate and reliable. However, Advantech Co., Ltd. assumes no responsibility for its use, nor for any infringements of the rights of third parties, which may result from its use.

Acknowledgements

Intel and Pentium are trademarks of Intel Corporation.
Microsoft Windows and MS-DOS are registered trademarks of Microsoft Corp.
All other product names or trademarks are properties of their respective owners.

This Manual Covers the Following Models:

PPC-300SW ADL_N series

- PPC-315SW ADL_N
- PPC-318SW ADL_N
- PPC-321SW ADL_N

Part No.
Printed in Taiwan

Edition 1
July 2024

Product Warranty (2 years)

Advantech warrants to you, the original purchaser, that each of its products will be free from defects in materials and workmanship for two years from the date of purchase.

This warranty does not apply to any products which have been repaired or altered by persons other than repair personnel authorized by Advantech, or which have been subject to misuse, abuse, accident or improper installation. Advantech assumes no liability under the terms of this warranty as a consequence of such events.

Because of Advantech's high quality-control standards and rigorous testing, most of our customers never need to use our repair service. If an Advantech product is defective, it will be repaired or replaced at no charge during the warranty period. For out-of-warranty repairs, you will be billed according to the cost of replacement materials, service time and freight. Please consult your dealer for more details.

If you think you have a defective product, follow these steps:

1. Collect all the information about the problem encountered. (For example, CPU speed, Advantech products used, other hardware and software used, etc.) Note anything abnormal and list any onscreen messages you get when the problem occurs.
2. Call your dealer and describe the problem. Please have your manual, product, and any helpful information readily available.
3. If your product is diagnosed as defective, obtain an RMA (return merchandise authorization) number from your dealer. This allows us to process your return more quickly.
4. Carefully pack the defective product, a fully-completed Repair and Replacement Order Card and a photocopy proof of purchase date (such as your sales receipt) in a shippable container. A product returned without proof of the purchase date is not eligible for warranty service.
5. Write the RMA number visibly on the outside of the package and ship it prepaid to your dealer.

Declaration of Conformity

CE

This product has passed the CE test for environmental specifications when shielded cables are used for external wiring. We recommend the use of shielded cables. This kind of cable is available from Advantech. Please contact your local supplier for ordering information.

FCC Class B

Note: This equipment has been tested and found to comply with the limits for a Class B digital device, pursuant to part 15 of the FCC Rules. These limits are designed to provide reasonable protection against harmful interference when the equipment is operated in a commercial environment. This equipment generates, uses, and can radiate radio frequency energy and, if not installed and used in accordance with the instruction manual, may cause harmful interference to radio communications. Operation of this equipment in a residential area is likely to cause harmful interference in which case the user will be required to correct the interference at his own expense.

Technical Support and Assistance

1. Visit the Advantech web site at www.advantech.com/support where you can find the latest information about the product.
2. Contact your distributor, sales representative, or Advantech's customer service center for technical support if you need additional assistance. Please have the following information ready before you call:
 - Product name and serial number
 - Description of your peripheral attachments
 - Description of your software (operating system, version, application software, etc.)
 - A complete description of the problem
 - The exact wording of any error messages

Warnings, Cautions and Notes

Warning! *Warnings indicate conditions, which if not observed, can cause personal injury!*
Les avertissements indiquent des conditions qui, si elles ne sont pas respectées, peuvent provoquer des blessures !



Caution! *Cautions are included to help you avoid damaging hardware or losing data. e.g. There is a danger of a new battery exploding if it is incorrectly installed. Do not attempt to recharge, force open, or heat the battery. Replace the battery only with the same or equivalent type recommended by the manufacturer. Discard used batteries according to the manufacturer's instructions.*



Des précautions sont incluses pour vous aider à éviter d'endommager le matériel ou de perdre des données. par exemple. Il existe un risque d'explosion d'une nouvelle batterie si elle n'est pas correctement installée. N'essayez pas de recharger, d'ouvrir de force ou de chauffer la batterie. Remplacez la batterie uniquement par une pile identique ou équivalente recommandée par le fabricant. Jetez les piles usagées conformément aux instructions du fabricant.

Note! *Notes provide optional additional information.*



Safety Instructions

1. Read these safety instructions carefully.
2. Keep this User Manual for later reference.
3. Disconnect this equipment from any AC outlet before cleaning. Use a damp cloth. Do not use liquid or spray detergents for cleaning.
4. For plug-in equipment, the power outlet socket must be located near the equipment and must be easily accessible.
5. Keep this equipment away from humidity.

6. Put this equipment on a reliable surface during installation. Dropping it or letting it fall may cause damage.
7. The openings on the enclosure are for air convection. Protect the equipment from overheating. **DO NOT COVER THE OPENINGS.**
8. Make sure the voltage of the power source is correct before connecting the equipment to the power outlet.
9. Position the power cord so that people cannot step on it. Do not place anything over the power cord.
10. All cautions and warnings on the equipment should be noted.
11. If the equipment is not used for a long time, disconnect it from the power source to avoid damage by transient overvoltage.
12. Never pour any liquid into an opening. This may cause fire or electrical shock.
13. Never open the equipment. For safety reasons, the equipment should be opened only by qualified service personnel.
14. If one of the following situations arises, get the equipment checked by service personnel:
 - The power cord or plug is damaged.
 - Liquid has penetrated into the equipment.
 - The equipment has been exposed to moisture.
 - The equipment does not work well, or you cannot get it to work according to the user's manual.
 - The equipment has been dropped and damaged.
 - The equipment has obvious signs of breakage.
15. **DO NOT LEAVE THIS EQUIPMENT IN AN ENVIRONMENT WHERE THE STORAGE TEMPERATURE MAY GO BELOW -20° C (-4° F) OR ABOVE 60° C (140° F) THIS COULD DAMAGE THE EQUIPMENT. THE EQUIPMENT SHOULD BE IN A CONTROLLED ENVIRONMENT.**
16. **CAUTION: DANGER OF EXPLOSION IF BATTERY IS INCORRECTLY REPLACED. REPLACE ONLY WITH THE SAME OR EQUIVALENT TYPE RECOMMENDED BY THE MANUFACTURER, DISCARD USED BATTERIES ACCORDING TO THE MANUFACTURER'S INSTRUCTIONS.**
17. In accordance with the IEC 704-1:1982 specifications, the sound pressure level at the operator position does not exceed 70 dB (A).
18. **DISCLAIMER:** These instructions are provided according to IEC 704-1. Avantech disclaims all responsibility for the accuracy of any statements contained herein.
19. This product is not intended for use by children (this product is not a toy).
20. This equipment is not suitable for use in locations where children are likely to be present.
21. **Caution:** The wire of the protective bonding conductor shall be green-and-yellow, 22AWG/0.3mm² minimum.
22. This product is intended to be supplied by a UL listed (Certificate) power supply with a mating connector, output rated 24Vdc, 5A, Tma 50 degree C minimum and altitude 2000m. If need further assistance, please contact manufacture or UL File owner or brand owner for additional information.

安全指示

1. 請仔細閱讀此安全操作說明。
2. 請妥善保存此用戶手冊供日後參考。
3. 用濕抹布清洗設備前，請從插座拔下電源線。請不要使用液體或去汙噴霧劑清洗設備。
4. 對於使用電源線的設備，設備周圍必須有容易接觸到的電源插座。
5. 請不要在潮濕環境中使用設備。
6. 請在安裝前確保設備放置在可靠的平面上，意外跌落可能會導致設備損壞。
7. 設備外殼的開口是用於空氣對流，從而防止設備過熱。請不要覆蓋這些開口。
8. 當您連接設備到電源插座前，請確認電源插座的電壓是否符合要求。
9. 請將電源線佈置在人們不易絆到的位置，並不要在電源線上覆蓋任何雜物。
10. 請注意設備上的所有警告和注意標示。
11. 如果長時間不使用設備，請將其同電源插座斷開，避免設備被超標的電壓波動損壞。
12. 請不要讓任何液體流入通風口，以免引起火災或者短路。
13. 請不要自行打開設備。為了確保您的安全，請由經過認證的工程師來打開設備。
14. 如遇下列情況，請由專業人員來維修：
 - 電源線或者插頭損壞；
 - 設備內部有液體流入；
 - 設備曾暴露在過於潮濕的環境中使用；
 - 設備無法正常工作，或您無法通過用戶手冊來使其正常工作；
 - 設備跌落或者損壞；
 - 設備有明顯的外觀破損。
15. 請不要把設備保存在超出我們建議的溫度範圍的環境，即不要低於 -20°C (-4°F) 或高於 60°C (140°F)，否則可能會損壞設備。
16. 注意：如果電池放置不正確，將有爆炸的危險。因此，只可以使用製造商推薦的同一種或者同等型號的電池進行替換。請按照製造商的指示處理舊電池。
17. 根據 IEC 704-1:1982 的規定，操作員所在位置的音量不可高於 70dB(A)。
18. 限制區域：請勿將設備安裝於限制區域使用。
19. 免責聲明：該安全指示符合 IEC 704-1 的要求。研華公司對其內容的準確性不承擔任何法律責任。
20. 使用過度恐傷害視力。
21. 使用 30 分鐘請休息 10 分鐘。
22. 未滿 2 歲幼兒不看螢幕，2 歲以上每天看螢幕不要超過 1 小時。
23. 本產品為國內裝置使用時，其電源僅限使用架構電源模組所提供電源直流輸入，不得使用交流電源及附加其他電源轉換裝置提供電源這者，其電源輸入電壓及電流請依說明書規定使用。
24. 本產品由帶有對接連接器的 UL 認證電源供電，額定輸出為 24Vdc, 5A, Tma 最低溫度為攝氏 50 度，海拔高度為 2000m。如果需要進一步協助，請聯絡製造商或 UL 文件所有者或品牌所有者以獲取更多資訊。

Safety Precaution - Static Electricity

For Skilled person follow these simple precautions to protect yourself from harm and the products from damage.

- To avoid electrical shock, always disconnect the power from your PC chassis before you work on it. Don't touch any components on the CPU card or other cards while the PC is on.
- Disconnect power before making any configuration changes. The sudden rush of power as you connect a jumper or install a card may damage sensitive electronic components.

Content

Chapter 1	General Information	1
1.1	Introduction	2
1.2	Specifications	2
1.2.1	General	2
1.2.2	System Kernel.....	2
1.2.3	Communication Interface	2
1.2.4	LCD Panel.....	3
1.2.5	Touchscreen.....	3
1.2.6	Environment.....	3
1.2.7	EMC and Safety	3
1.2.8	Power	3
1.2.9	External I/O	4
1.3	Dimensions and Cutout	4
1.3.1	PPC-315SW ADL_N	4
1.3.2	PPC-318SW ADL_N	5
1.3.3	PPC-321SW ADL_N	6
Chapter 2	System Setup	7
2.1	Transport and Unpacking	8
2.1.1	Transport	8
2.1.2	Unpacking and Setup.....	8
	Figure 2.1 Power Connector and Power Lines.....	8
	Figure 2.2 Power LED	9
2.2	System configuration	9
2.2.1	Rear Bracket Removal.....	9
	Figure 2.3 Rear Cover Removal.....	9
2.2.2	AT/ATX Jumper Setting (JP5)	10
	Table 2.1: AT/ATX Function	10
2.2.3	Installation of 2.5" SSD	11
	Figure 2.4 SSD Installation	11
2.2.4	Installation of iDoor Module	11
	Figure 2.5 iDoor Blank Cover Removal.....	11
	Figure 2.6 iDoor Module Installation.....	12
	Figure 2.7 GPIO+USB Module Installation.....	12
	Figure 2.8 GPIO and USB Connectors	13
2.2.5	Installation of PCIe Expansion Cards	13
	Figure 2.9 PCIe Slot Cover Removal	13
	Figure 2.10 Installing the Rear Cover.....	13

	Figure 2.11 Expansion Bracket Installation	14
	Figure 2.12 Installing a Riser Card	14
	Figure 2.13 Installing PCIe Expansion Card	14
	Figure 2.14 Expansion Cover Installation.....	15
2.2.6	Installation of RFID Reader.....	15
	Figure 2.15 RFID Reader Installation	15
2.3	Panel Mount	16
	Figure 2.16 Panel Mounting – Positioning.....	16
	Figure 2.17 Panel Mounting (1).....	17
	Figure 2.18 Panel Mounting (2).....	17
2.4	VESA Mount	17
	Figure 2.19 VESA Mounting	18
2.5	Cabinet Installation and Earth Grounding Setup.....	18
2.5.1	Installing PPC into Cabinet.	18
	Figure 2.20 Cabinet Installation.....	18
2.5.2	System Wiring	18
	Figure 2.21 System Wiring	19

Chapter 3 BIOS Setup20

3.1	BIOS Setup.....	21
3.2	Entering Setup.....	21
3.2.1	Main Setup	22
3.2.2	Advanced BIOS Features Setup.....	23
3.2.3	Chipset Configuration.....	35
3.2.4	Security	37
3.2.5	Boot.....	38
3.2.6	Save & Exit.....	39

Appendix A Connectors40

A.1	Jumper and Connector Location	41
A.1.1	Board Layout.....	41
	Figure A.1 Board Layout - Top View	41
	Table A.1: Board Placement	41
A.2	Jumper Settings and Descriptions.....	42
A.2.1	CMOS Clear Function (JCMOS1).....	42
	Table A.2: CMOS Clear Function.....	42
A.2.2	COM1 Signal Select (JP3)	42
	Table A.3: COM1 Signal Select	42
A.2.3	Touchscreen Type Select (JP4)	43
	Table A.4: Touchscreen Type Select.....	43
A.3	Connector Pin Definition.....	43
A.3.1	Remote Power Button Connector (CN9).....	43

	Table A.5: Remote Power Button Connector (CN9)	43
A.3.2	RS-232/422/485 Connector (COM1, COM2).....	44
	Table A.6: RS-232/422/485 Connector (COM1, COM2).....	44
A.3.3	GPIO Connector (CN13).....	44
	Table A.7: GPIO Connector (CN13).....	44
A.3.4	Ethernet Connector LEDs	45
	Table A.8: 2.5G Ethernet Connector (LAN) LEDs	45

Appendix B PCI / PCIe46

B.1	Load Current of PCIe Slot	47
	Table B.1: Total Load Current of PCIe Slot.....	47
B.2	Load Current of PCI Slot	47
	Table B.2: Total Load Current of PCI Slot.....	47

Chapter 1

General Information

1.1 Introduction

The PPC-300 ADL_N panel PC is equipped with TFT LCD, and low-power Intel® N97 quad-core processor to provide high performance computing in a compact and fanless system.

- Intel® Alder Lake N97 2.0GHz quad-core processor
- 15.6"/18.5"/21.5" true-flat TFT LCD with projected capacitive touch control
- Fanless design with low power consumption
- Supports one M.2 M Key 2242/2280 (SATA or NVMe PCIe x1) slot, and one 2.5" SATA bay for storage
- Supports dual displays (1 x external DP)
- Supports iDoor
- Support PCI or PCIe
- Supports VESA 100
- IP66-rated front panel

1.2 Specifications

1.2.1 General

- **BIOS:** AMI UEFI
- **Cooling System:** Fanless design
- **Speaker:** 1 x 2W
- **Dimensions (W x H x D):**
 - PPC-315SW: 395.7 x 245.1 x 50.4 mm (15.6 x 9.6 x 2.0 inch)
 - PPC-318SW: 464.5 x 285.5 x 53.4 mm (18.3 x 11.2 x 2.1 inch)
 - PPC-321SW: 529.6 x 321.3 x 53.4 mm (20.9 x 12.6 x 2.1 inch)
- **Weight (Net):**
 - PPC-315SW: 4.26 kg (9.4 lb)
 - PPC-318SW: 5.17 kg (11.4 lb)
 - PPC-321SW: 6.24 kg (13.8 lb)
- **Mounting:** VESA mount (75 x 75), panel
- **OS Support:** Windows 10 LTSC, Windows 11, Linux, Android

1.2.2 System Kernel

- **CPU:**
 - Intel® Alder Lake-N N97 quad core processor, 2.0 GHz, up to 3.6GHz with turbo, 6 MB cache
- **Memory:**
 - 1 x DDR5 4800MHz SO-DIMM (up to 16GB)
- **Watchdog Timer:** Programmable as 1 ~ 255 second

1.2.3 Communication Interface

- **Serial Port:** 2 x RS-232/422/485
- **LAN Port:** 2 x 10/100/1000/2500 Mbps RJ45 LAN (Intel® I226-LM)
- **Expansion Slots:**
 - 1 x M.2 B key 2242 or 3042/3052 (SATA, PCIe x1, USB 3.0 & SIM slot)
 - 1 x M.2 E key 2230 (PCIe & USB 2.0)
 - 1 x iDoor (optional)
 - 1 x PCI or PCIe x4 (optional)

Note: Use either the M.2 B key slot or the PCI slot for PCIe signals.

- **Storage Slots:**

- 1 x M.2 M key 2242/2280 (SATA or NVMe PCIe x1)
- 1 x 2.5" SATA bay

Note: You can only use either 2.5" SSDs or M.2 B key slot for SATA signals.

- **Others:**

- 2 x USB 3.2
- 2 x USB 2.0
- 1 x DP
- 1 x Line out

1.2.4 LCD Panel

	PPC-315SW ADL_N	PPC-318SW ADL_N	PPC-321SW ADL_N
Display Type	15.6" FHD TFT LED LCD	18.5" WXGA TFT LED LCD	21.5" FHD TFT LED LCD
Max. Resolution	1920 x 1080	1366 x 768	1920 x 1080
Viewing Angle	89 (left), 89 (right), 89 (up), 89 (down)	85 (left), 85 (right), 80 (up), 80 (down)	89 (left), 89 (right), 89 (up), 89 (down)
Luminance	350 cd/m ²	450 cd/m ²	250 cd/m ²
Contrast Ratio	800	1000	1000
Backlight Lifetime	50,000 hrs (min.)	50,000 hrs (min.)	50,000 hrs (min.)

1.2.5 Touchscreen

- **Light Transmission:** >86%
- **Type:** Projected capacitive (P-CAP) multi-touch
- **Controller:** USB interface

1.2.6 Environment

- **Operating Temperature:** -10 ~ 50 °C (-32 ~ 122 °F)
- **Storage Temperature:** -20 ~ 60 °C (-4 ~ 140 °F)
- **Humidity:** 95% @ 40 °C, non-condensing
- **Ingress Protection:** Compliant with IP66 on front panel
- **Shock:** Operating 10 G peak acceleration (11 ms duration), follows IEC 60068-2-27
- **Vibration:** Operating random vibration test 5~500Hz, 2Grms with SSD, follows IEC 60068-2-64

1.2.7 EMC and Safety

- **EMC:** CE, FCC Class B, BSMI, EN60601-1-2, UKCA
- **Safety:** CB, UL, CCC, UKCA

1.2.8 Power

- **Input Voltage:** 24VDC ± 20%
- **Power Consumption** (Burn-in test 8.1 in Windows 10 64-bit):
PPC-315SW: 35 W
PPC-318SW: 40 W
PPC-321SW: 45 W

1.2.9 External I/O

The arrangement of I/O ports is shown below.

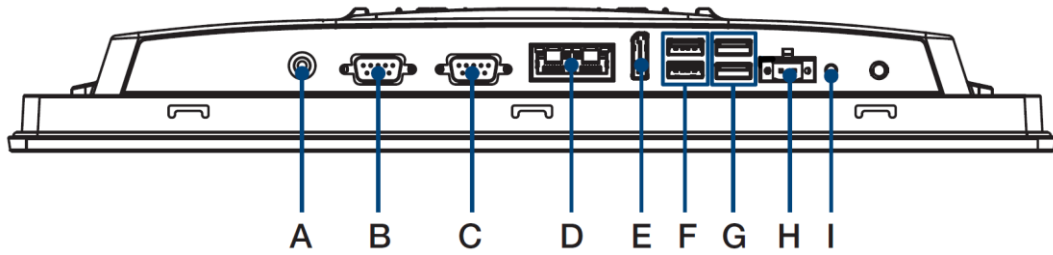

- | | |
|-------------------------|-----------------|
| A. Line Out | F. 2 x USB 3.2 |
| B. COM1: RS-232/422/485 | G. 2 x USB 2.0 |
| C. COM2: RS-232/422/485 | H. DC-in |
| D. 2 x LAN | I. Power button |
| E. DP | |

1.3 Dimensions and Cutout

1.3.1 PPC-315SW ADL_N

- **Dimensions (W x H x D):** 395.7 x 245.1 x 50.4 mm (15.6 x 9.6 x 2.0 inch)

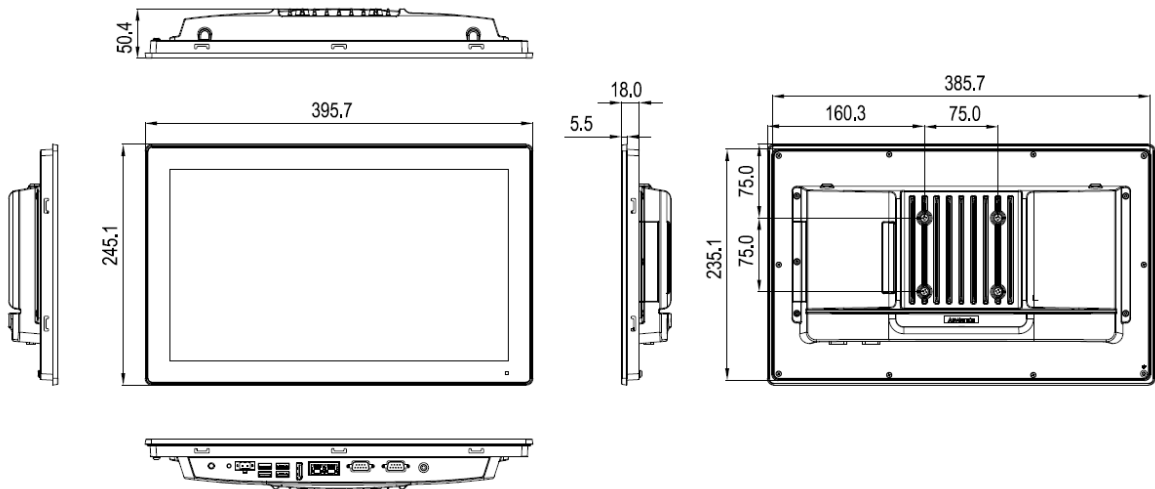

- **Cutout Dimensions:**
386.8 x 236.2 mm (15.23 x 9.30 inch)
Corner=R6mm (±0.5mm)

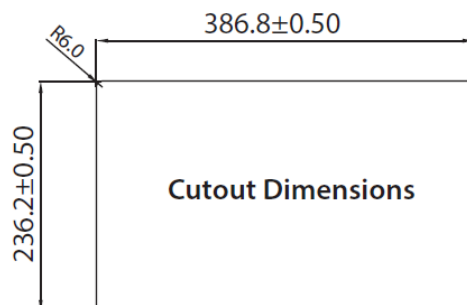

1.3.2 PPC-318SW ADL_N

- **Dimensions (W x H x D):** 464.5 x 285.5 x 53.4 mm (18.3 x 11.2 x 2.1 inch)

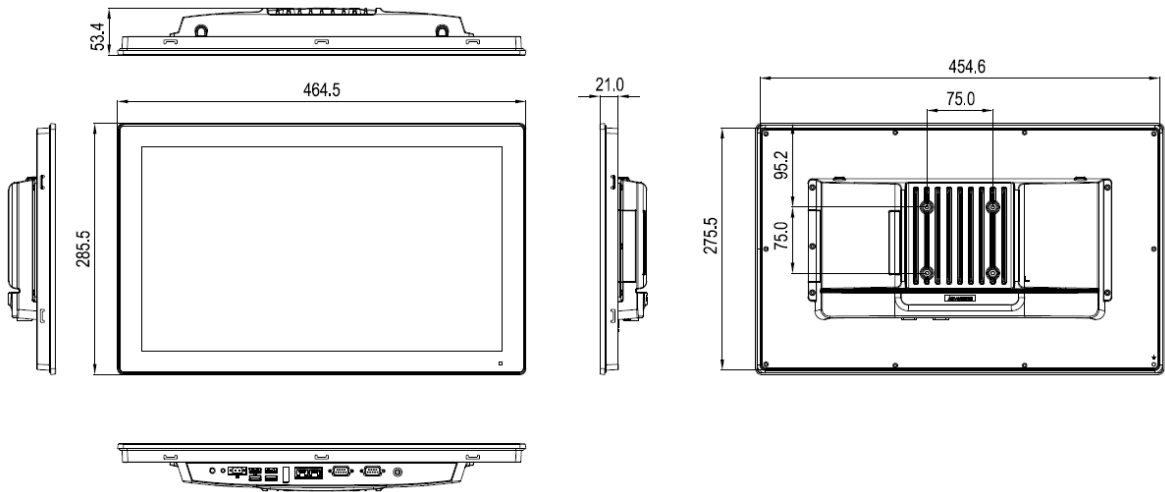

- **Cutout Dimensions:**
455.6 x 276.6 mm (17.94 x 10.89 inch)
Corner=R6mm (±0.5mm)

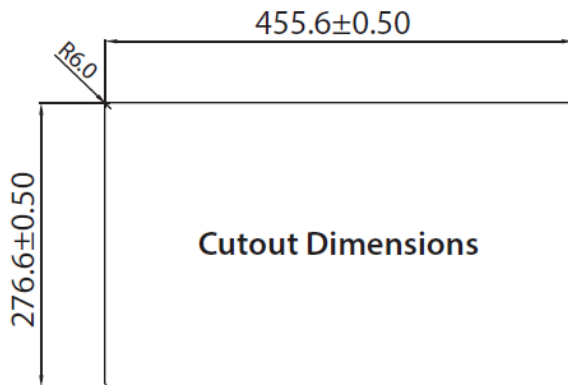

1.3.3 PPC-321SW ADL_N

- **Dimensions (W x H x D):** 529.6 x 321.3 x 53.4 mm (20.9 x 12.6 x 2.1 inch)

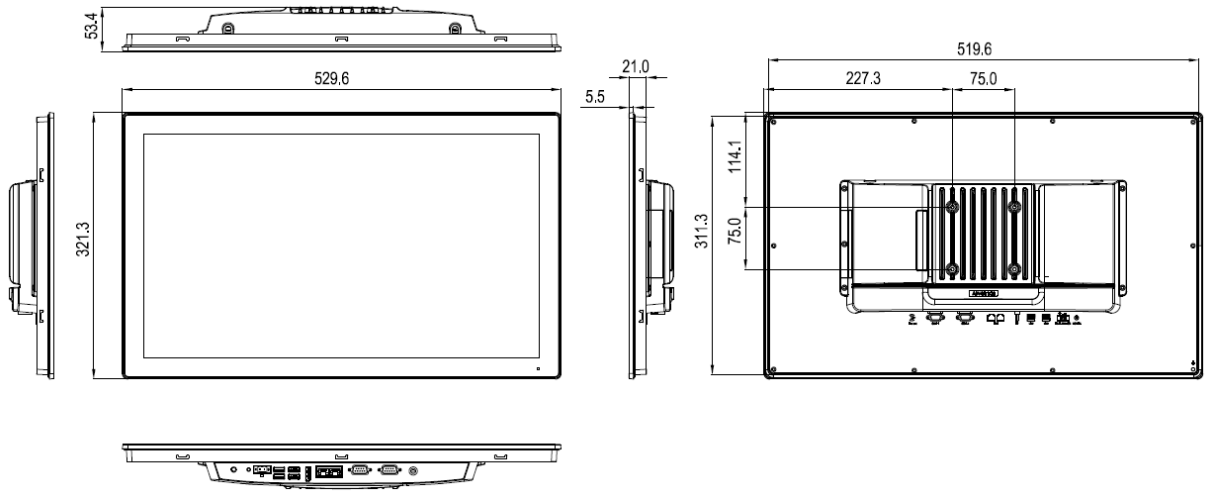

- **Cutout Dimensions:**
520.7 x 312.4 mm (20.5 x 12.3 inch)
Corner=R6mm (± 0.5 mm)

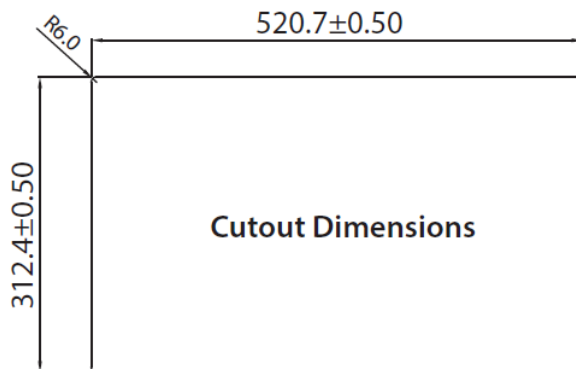

Chapter 2

System Setup

2.1 Transport and Unpacking

2.1.1 Transport

When accepting a delivery, please check the packaging for visible transport damage and check the delivery for completeness by comparing it with your order. If you notice any shipping damage or inconsistencies between the contents and your order, please inform the responsible delivery service immediately.

During transportation, the PPC should be protected from excessive mechanical stress. If the PPC is transported or stored without packaging, shocks, vibrations, pressure and moisture may impact the unprotected unit. A damaged packaging indicates that ambient conditions have already had a massive impact on the device. Therefore, please use the original packaging during transportation and storage.

If the PPC is transported in cold weather or is exposed to extreme variations in temperature, make sure that moisture (condensation) does not build up on or inside the HMI device. Moisture can result in short-circuits in electrical circuits and damage the device. To avoid that, please store the PPC in a dry place and bring the PPC to room temperature before starting it up. If condensation occurs, a delay time of approximately 12 hours must be allowed to make sure the PPC is completely dry before the PPC is switched on.

2.1.2 Unpacking and Setup

Follow these steps to setup the PPC-300SW ADL_N device:

1. Unbox the PPC-300SW ADL_N device.
2. Adjust the power mode if necessary (default: AT mode), refer to Section 2.2.2 for details.
3. Connect the power connector to the 24 VDC power lines of a power adapter or in-house power source. DC power source complies with ES1 and PS2 requirements, has output rating of 24 Vdc, a minimum operating temperature of 50°C, and undergoes evaluation according to IEC/UL 60950-1 and/or IEC/UL 62368-1.

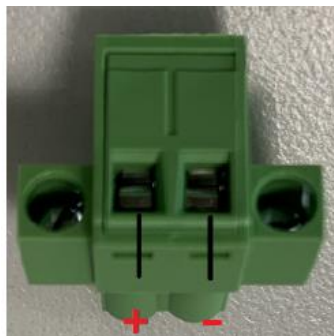



Figure 2.1 Power Connector and Power Lines

Warning! *The system may get damaged when the power is turned on and the power source is not connected to the correct pins.*
 *Le système peut être endommagé lorsque l'alimentation est allumée et que la source d'alimentation n'est pas connectée aux broches appropriées.*

4. Connect the power lines to the system power receptor using the terminal block suitable for 16 AWG min. Apply a torque value of 4.5 lb-in min. Ensure the use of copper conductors only, and the installation must be performed by a skilled person.
5. Power on the system. The power LED turns to blue.

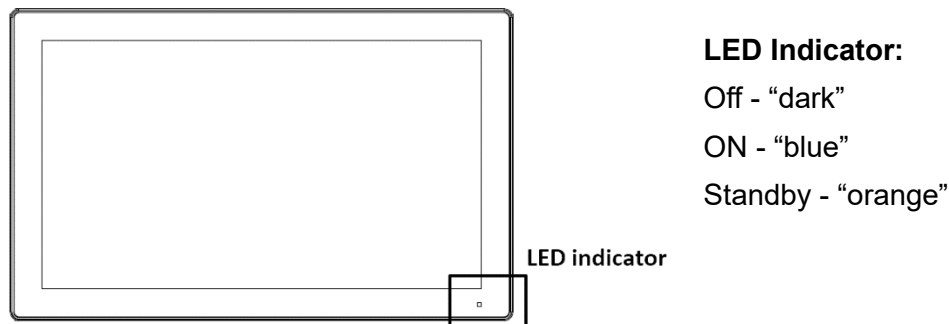

Figure 2.2 Power LED

6. Calibrate the touchscreen.

2.2 System configuration

While the initial system setup is performed by the dealer or system integrator before delivery, users may require access to adjust configuration such as interfaces or boot modes. Before powering on, open the rear bracket and ensure the correct power mode is selected.

2.2.1 Rear Bracket Removal

To modify settings or install new modules, the rear bracket of the system must be removed. It is attached with 8 screws, as illustrated below. After removing all screws, carefully lift the rear bracket and set it aside, taking care not to cause any damage to the system or the bracket in the process. The following diagrams use PPC-315SW ADL_N as a reference. All models share the same mechanical design.

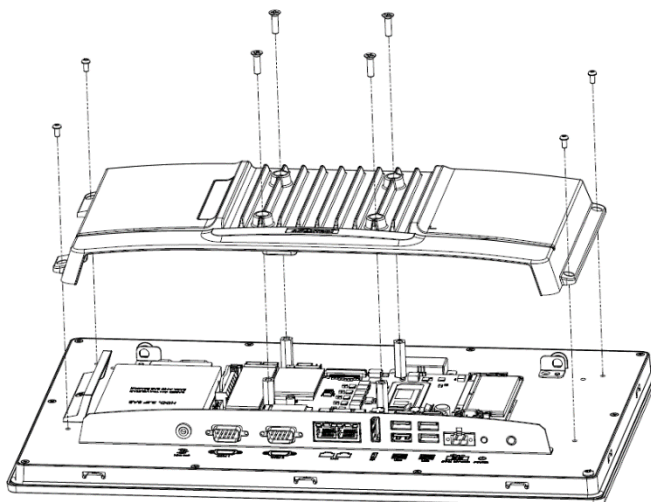

Figure 2.3 Rear Cover Removal

2.2.2 AT/ATX Jumper Setting (JP5)

This jumper on the PPC-300SW ADL_N motherboard, as indicated below, allows for the adjustment of the power mode

Table 2.1: AT/ATX Function

Description	This jumper is used to select Power ON mode
Default	(2-3)
(2-3)	ATX
(1-2)	AT

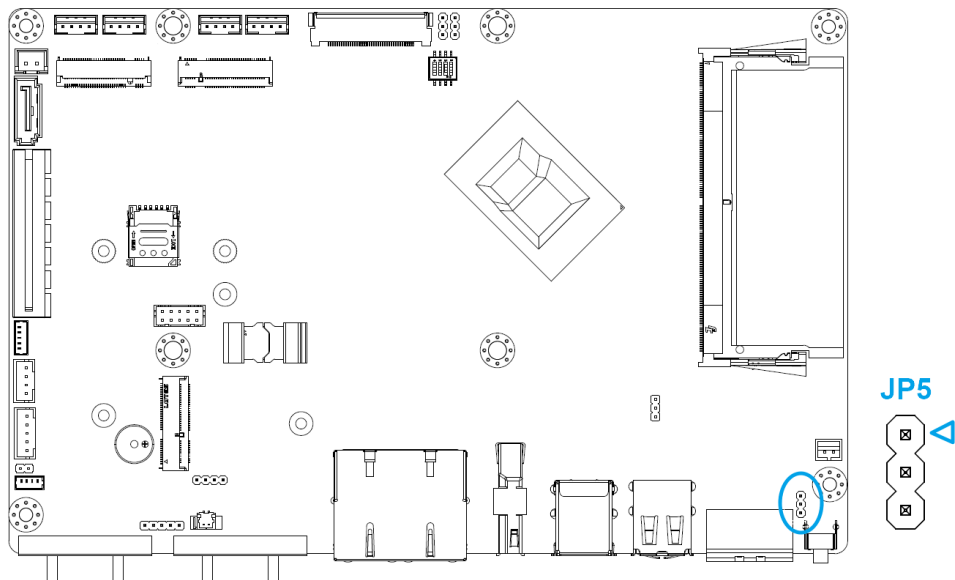
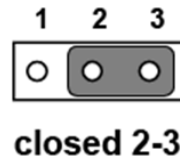
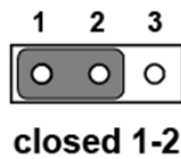

Warning! *Incorrect or undefined switches can cause damage to the system when powered on.*



Des commutateurs incorrects ou non définis peuvent endommager le système lors de la mise sous tension.

2.2.3 Installation of 2.5" SSD

1. Remove the rear cover. See Section 2.2.1.
2. Secure the SSD onto the bracket using four M3x4L screws.
3. Install the SSD and its bracket into the system.

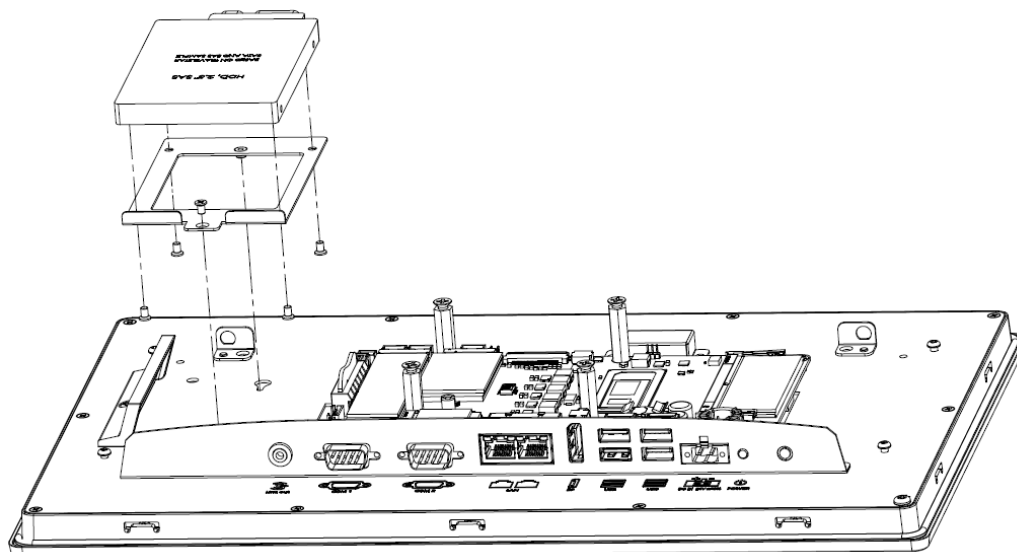

Figure 2.4 SSD Installation

4. Attach the rear cover to the chassis using the previously removed screws.

NOTE! The iDoor module and 2.5" SSD cannot be installed concurrently. Install an M.2 SSD if the iDoor module is required.



2.2.4 Installation of iDoor Module

1. Remove the rear cover. See Section 2.2.1.
2. Remove the blank cover for iDoor by removing the screw indicated below.

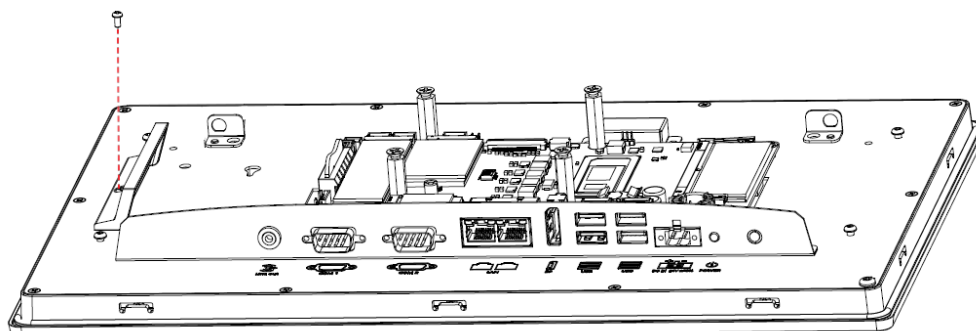

Figure 2.5 iDoor Blank Cover Removal

3. Install an iDoor module, and tighten the two screws to secure the module in place.

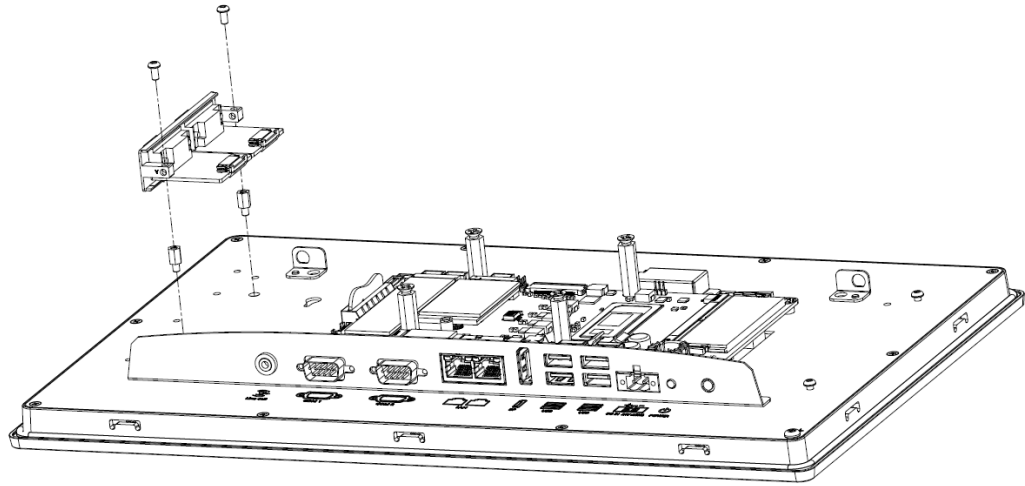

Figure 2.6 iDoor Module Installation

4. Attach the rear cover to the chassis using the previously removed screws.

2.2.4.1 Installation of GPIO+USB Module

1. Follow the instructions outlined in Section 2.2.4, Steps 1 and 2.
2. Install a GPIO+USB module (98R1P300S10), and tighten the two screws to secure the module in place.

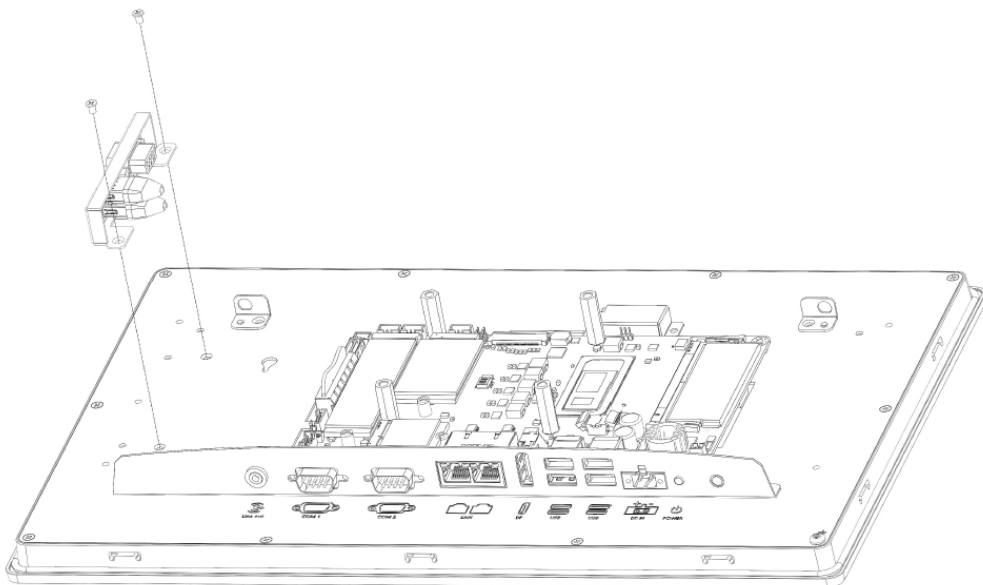

Figure 2.7 GPIO+USB Module Installation

3. Connect the USB cables and the GPIO cable to the corresponding connectors on the system motherboard.

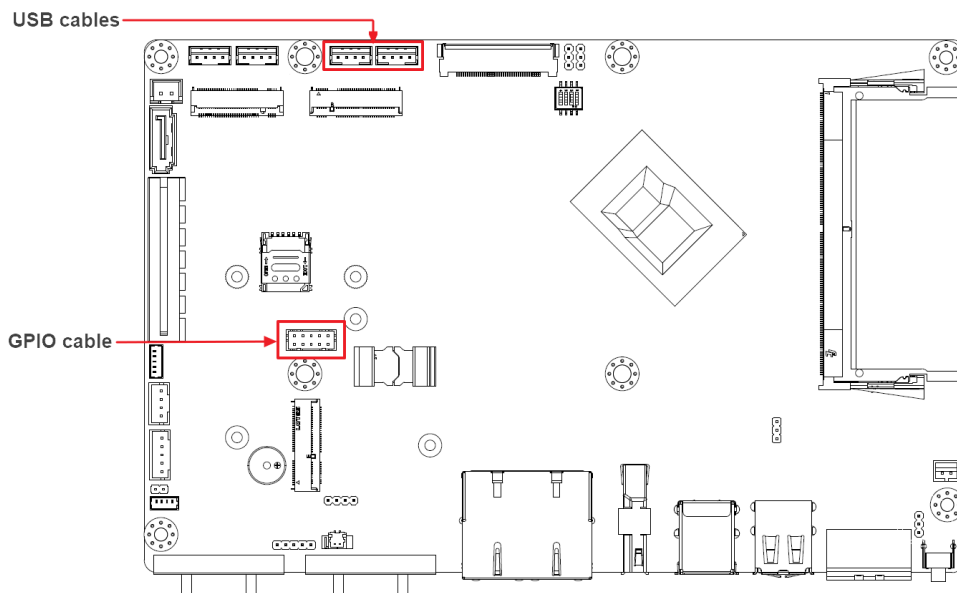

Figure 2.8 GPIO and USB Connectors

NOTE! *The GPIO+USB mode, the iDoor module and a 2.5" SSD cannot be installed concurrently. Please select the installation option that best suits your requirements.*



2.2.5 Installation of PCIe Expansion Cards

1. Remove the rear cover. See Section 2.2.1.
2. Remove the PCIe slot cover as shown below.

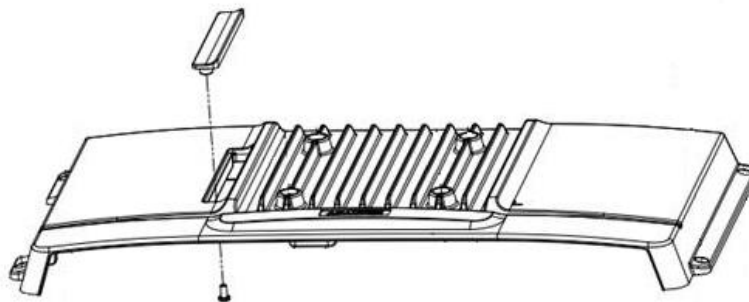

Figure 2.9 PCIe Slot Cover Removal

3. Secure the rear cover back to the chassis using four screws.

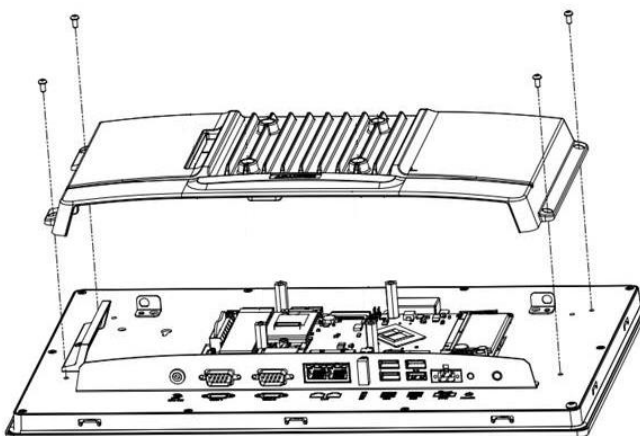

Figure 2.10 Installing the Rear Cover

4. Install the expansion bracket to the rear panel with four screws.

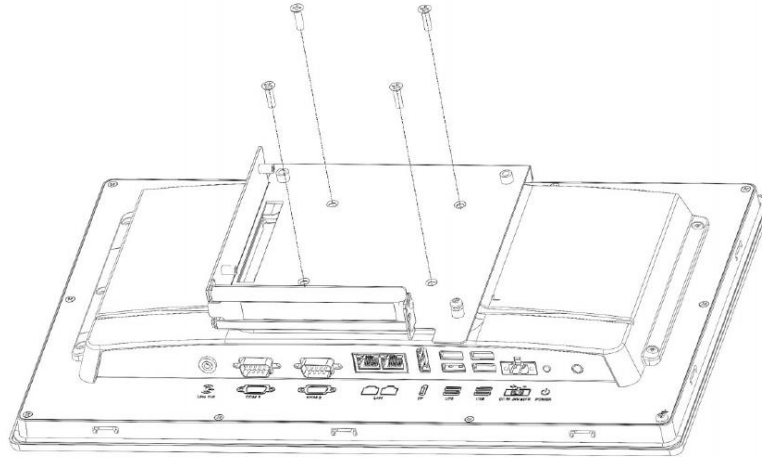

Figure 2.11 Expansion Bracket Installation

5. Insert the riser card into the PCIe slot, and secure the riser card using two screws.

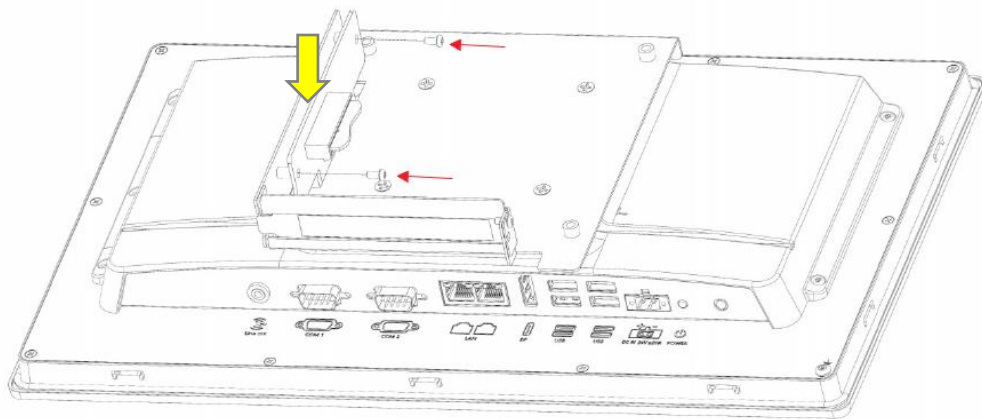

Figure 2.12 Installing a Riser Card

6. Install a PCIe expansion card into the riser card and lock it with a screw.

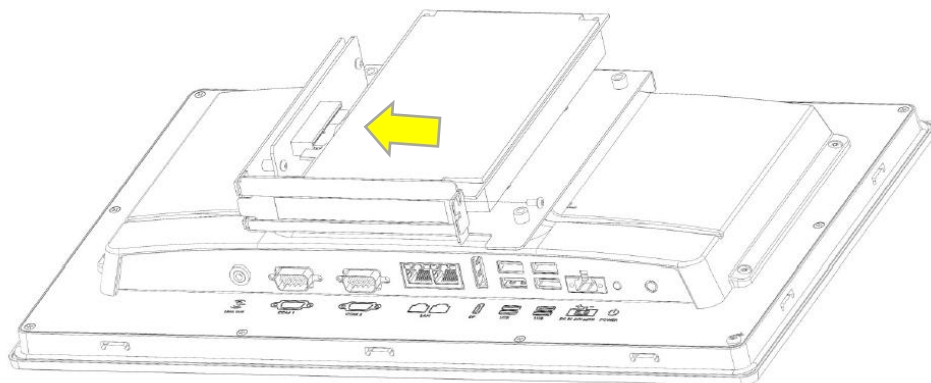

Figure 2.13 Installing PCIe Expansion Card

NOTE! The expansion slot supports a maximum card size of 175mm x 111mm x 18mm. Ensure your card dimensions do not exceed this limit for optimal compatibility and performance.



NOTE! Refer to Appendix B for the total load current supported by the PCIe expansion slot.



7. Affix the expansion cover with four screws.

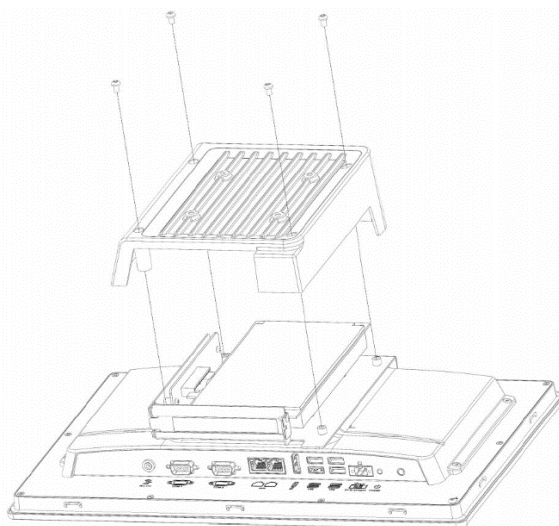

Figure 2.14 Expansion Cover Installation

NOTE! A PCIe expansion kit (98R1P300S00) is required for PCIe expansion card installation.



2.2.6 Installation of RFID Reader

1. Adjust the position of the RFID reader (98R3P300010) using the two screws.
2. Secure the RFID reader to the chassis with one screw.

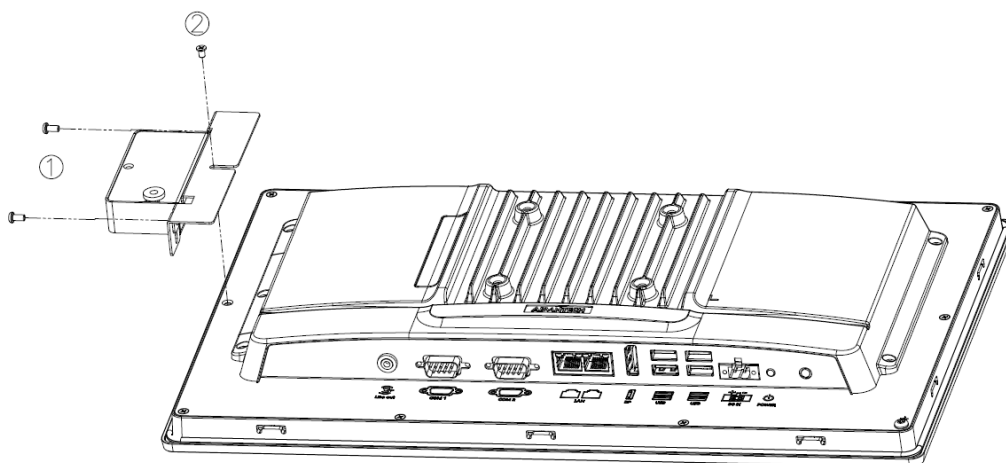
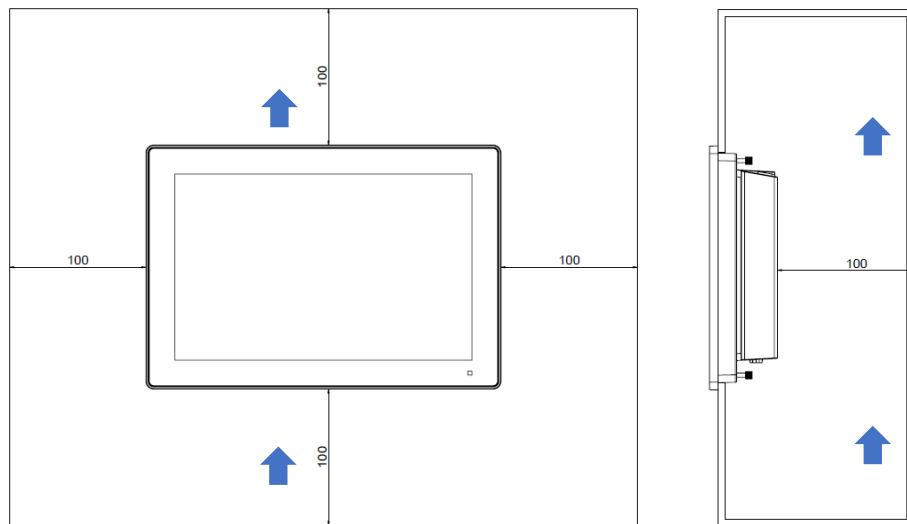

Figure 2.15 RFID Reader Installation

2.3 Panel Mount

Before installing the PPC-300SW ADL_N panel computer into the panel opening, ensure that the adhesive waterproof gasket on the front bezel is correctly positioned.

- Cut out a section from the panel based on the dimensions of the Panel PC. The dimensions for the panel opening are as follows:
 - PPC-315SW: 386.8 x 236.2 mm (15.23 x 9.30 inch)
 - PPC-318SW: 455.6 x 276.6 mm (17.94 x 10.89 inch)
 - PPC-321SW: 520.7 x 312.4 mm (20.5 x 12.3 inch)
- Install the PPC into the panel opening, ensuring adequate air circulation with a required clearance on all sides. Refer to the diagram for the minimum clearance (100mm), air inlet and outlet directions (blue arrows), and a suggested mounting panel thickness of less than 5mm (0.196").



Unit: mm

Figure 2.16 Panel Mounting – Positioning

- Retrieve the clamps with long screws from the accessory pack. Insert the clamps into the holes and slide the clamp in the direction shown in the diagram below. Securely hook the clamps around the four sides of the bezel for a firm hold.

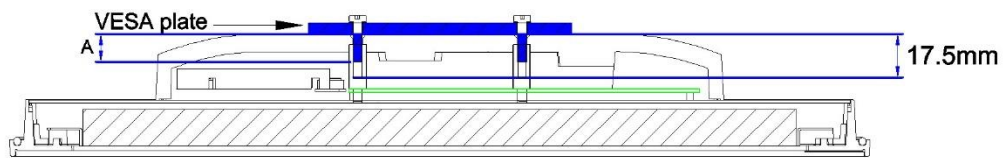

Note: Recommended screw thread depth "A" shall be more than 9.5mm.

Figure 2.19 VESA Mounting

2.5 Cabinet Installation and Earth Grounding Setup

Follow these steps to set up the PPC system, ensuring that the Ground pin of the PPC system is properly connected to the earth ground. This connection is crucial for optimizing the performance of the PPC system, including enhanced EMI immunity, ESD immunity, surge immunity, and system isolation. If the PPC system is embedded in a cabinet, make sure to connect the PPC system's ground, the cabinet's ground, and the earth ground together.

2.5.1 Installing PPC into Cabinet.

1. Connect the cabinet to earth ground.
2. Embed null PPC-300SW ADL_N system into the cabinet without any I/O cable and power.

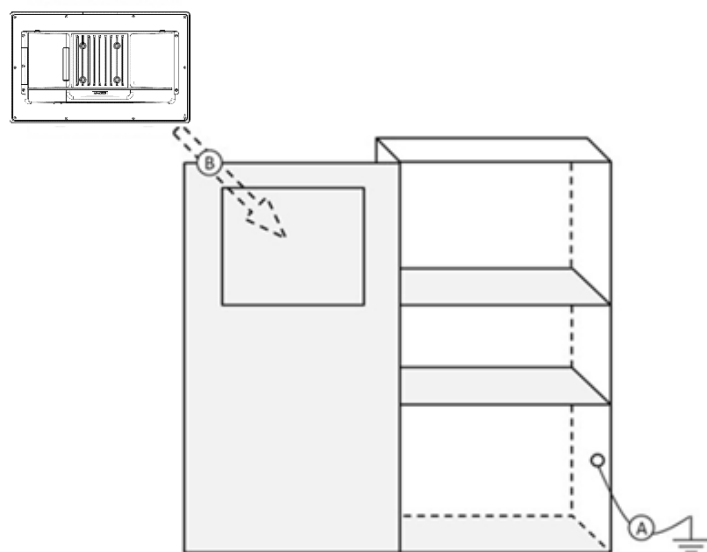

Figure 2.20 Cabinet Installation

2.5.2 System Wiring

1. Ground the cabinet to earth.
2. Ensure proper grounding for all cabinets.
3. Connect the power supply ground to the cabinet.
4. Connect the PPC-300SW ADL_N system's ground pin to the cabinet.
5. If necessary, connect I/O to the controller.
6. Connect the power supply's V+ and V- to the PPC-300SW ADL_N system.
7. Proceed step by step through steps 1 to 6, then power on the PPC-300SW ADL_N system.

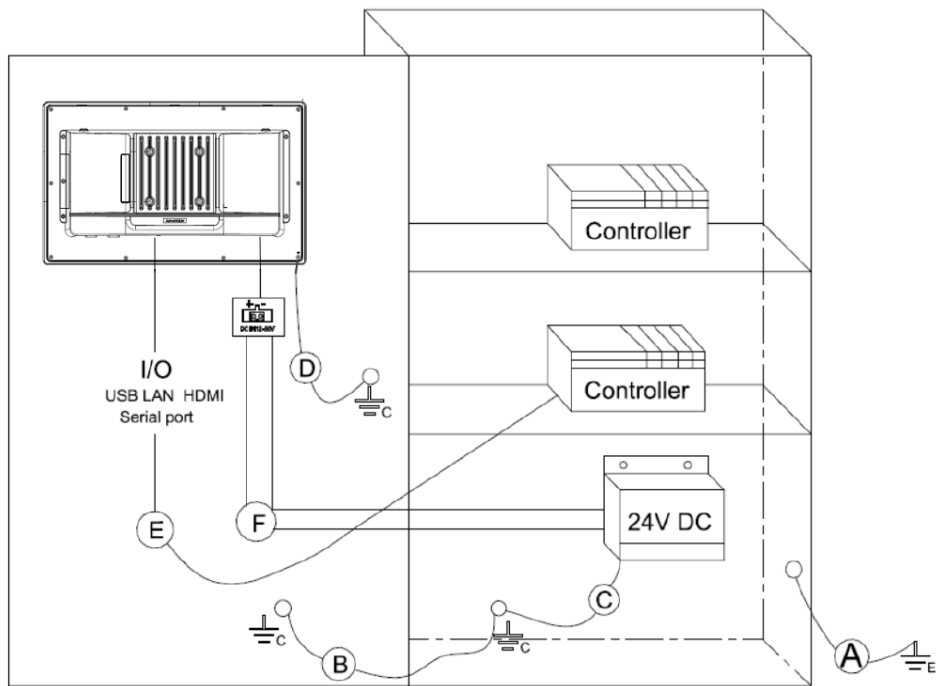

Figure 2.21 System Wiring

NOTE! Make sure all wires follow the installation guidelines to avoid performance issues.



Chapter 3

BIOS Setup

3.1 BIOS Setup

With the AMI BIOS Setup program, users can modify the BIOS settings and control various system features. This chapter describes the basic navigation of the BIOS Setup Utility.



AMI's BIOS ROM has a built-in setup program that allows users to modify the basic system configuration. The setup information is stored in flash ROM to ensure it is retained when the system is powered off.

3.2 Entering Setup

Turn on the computer and check for the patch code. If there is a number assigned to the patch code, it means that the BIOS supports your CPU. If there is no number assigned to the patch code, contact an Advantech application engineer to obtain an up-to-date patch code file. This will ensure that the CPU status is valid. After ensuring that you have a number assigned to the patch code, press to access the BIOS Setup Utility.

3.2.1 Main Setup

Upon entering the BIOS Setup Utility, users will be on the Main setup screen. At any point during the configuration, users can return to the Main setup screen by selecting the Main tab. There are two Main setup options, which are described in this section. The Main setup screen is shown below.

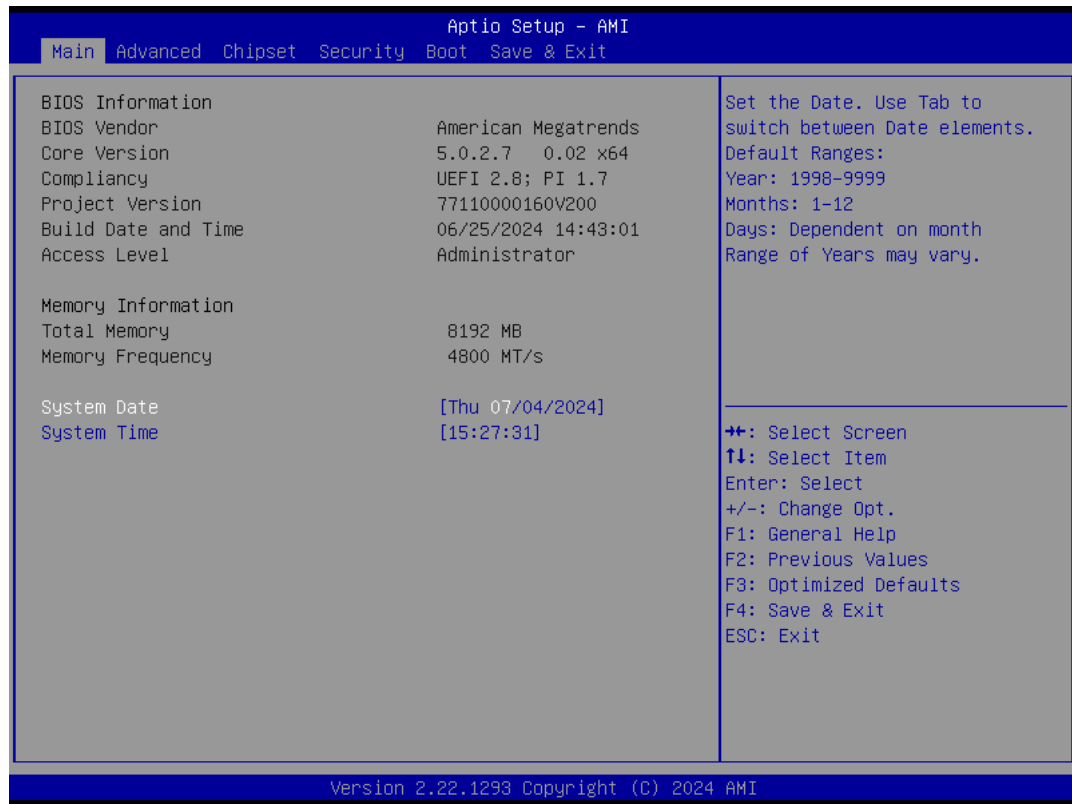

The Main BIOS setup screen has two main frames. The left frame displays all the options that can be configured. Grayed-out options cannot be configured, options in blue can. The right frame displays the key legend.

Above the key legend is an area reserved for a text message. When an option is selected in the left frame, it is highlighted in white. Often a text message will accompany it.

■ System Time/System Date

Use this option to change the system time and date. Highlight System Time or System Date using the <Arrow> keys. Enter new values through the keyboard. Press the <Tab> key or the <Arrow> keys to move between fields. The date must be entered in MM/DD/YY format. The time must be entered in HH:MM:SS format.

3.2.2 Advanced BIOS Features Setup

Select the Advanced tab from the PPC-300SW ADL_N setup screen to enter the Advanced BIOS Setup screen. You can select any of the items in the left frame of the screen, such as ACPI Settings and hit <enter> to go to the sub menu for that item. You can display an Advanced BIOS Setup option by highlighting it using the <Arrow> keys. All Advanced BIOS Setup options are described in this section. The Advanced BIOS Setup screen is shown below. The sub menus are described on the following pages.

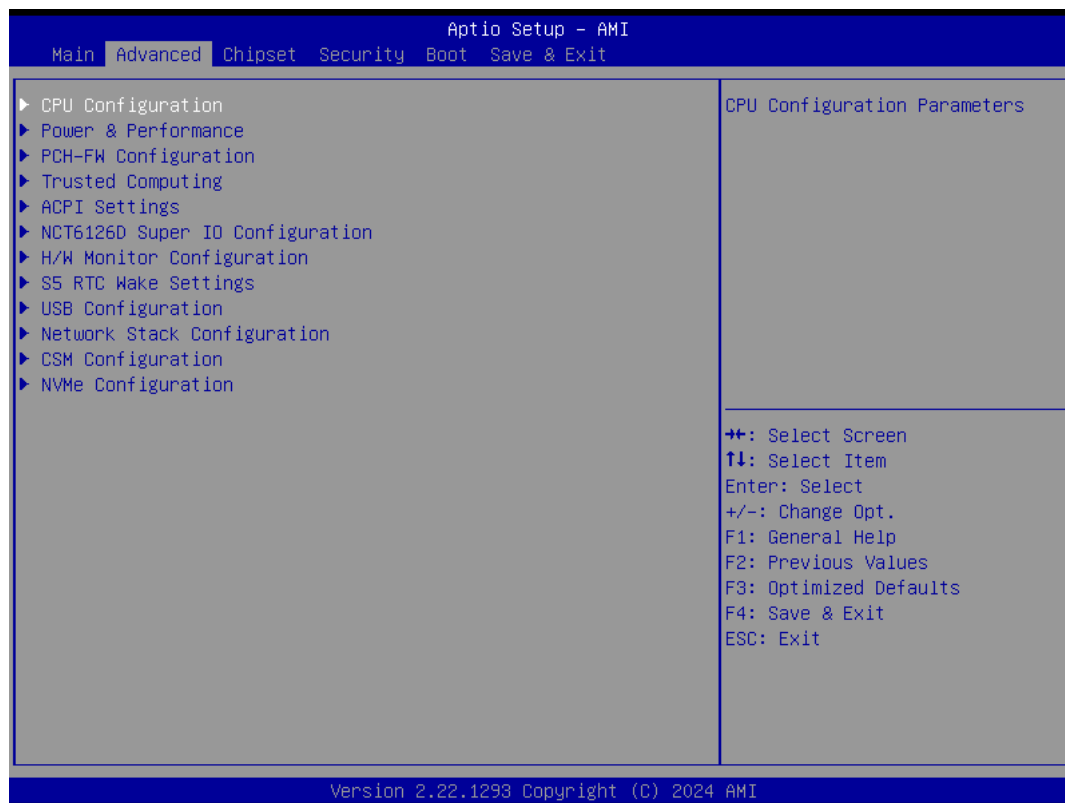

3.2.2.1 CPU Configuration

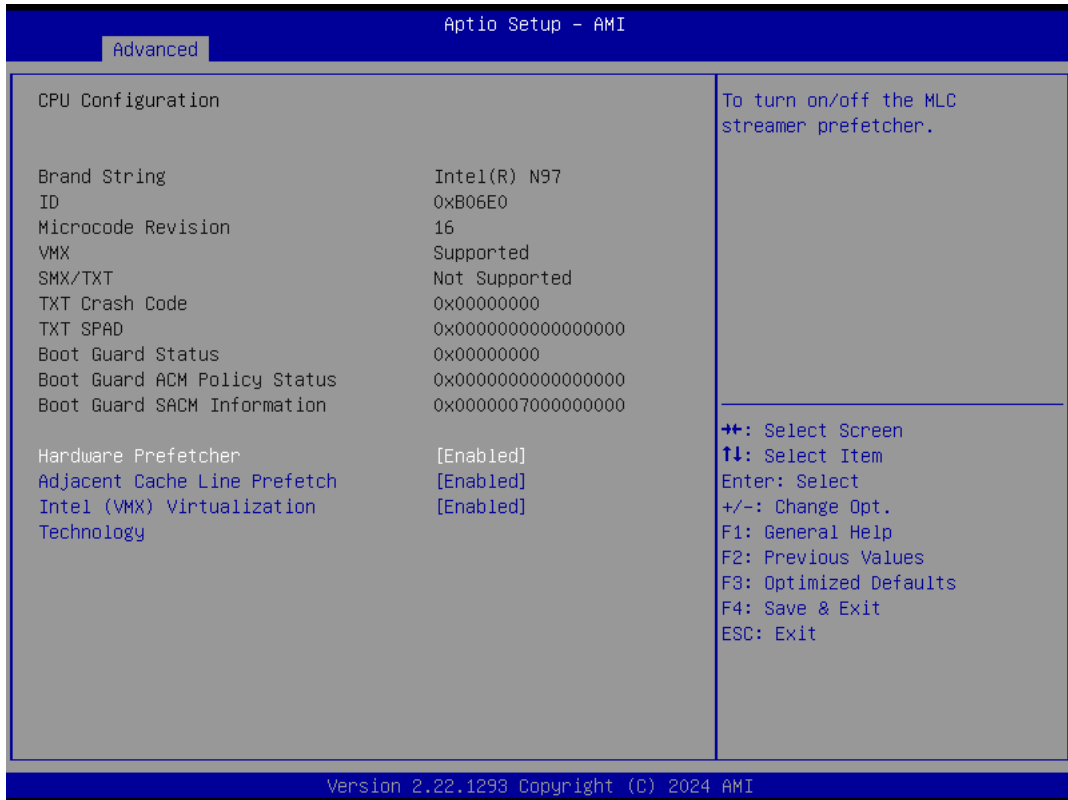

- **Hardware Prefetcher**
To turn on/off the MLC streamer prefetcher
- **Adjacent Cache Line Prefetch**
To turn on/off prefetching of adjacent cache lines
- **Intel (VMX) Virtualization Technology**
When enabled, a VMX can utilize the additional hardware capabilities provided by Vanderpool Technology

3.2.2.2 Power & Performance

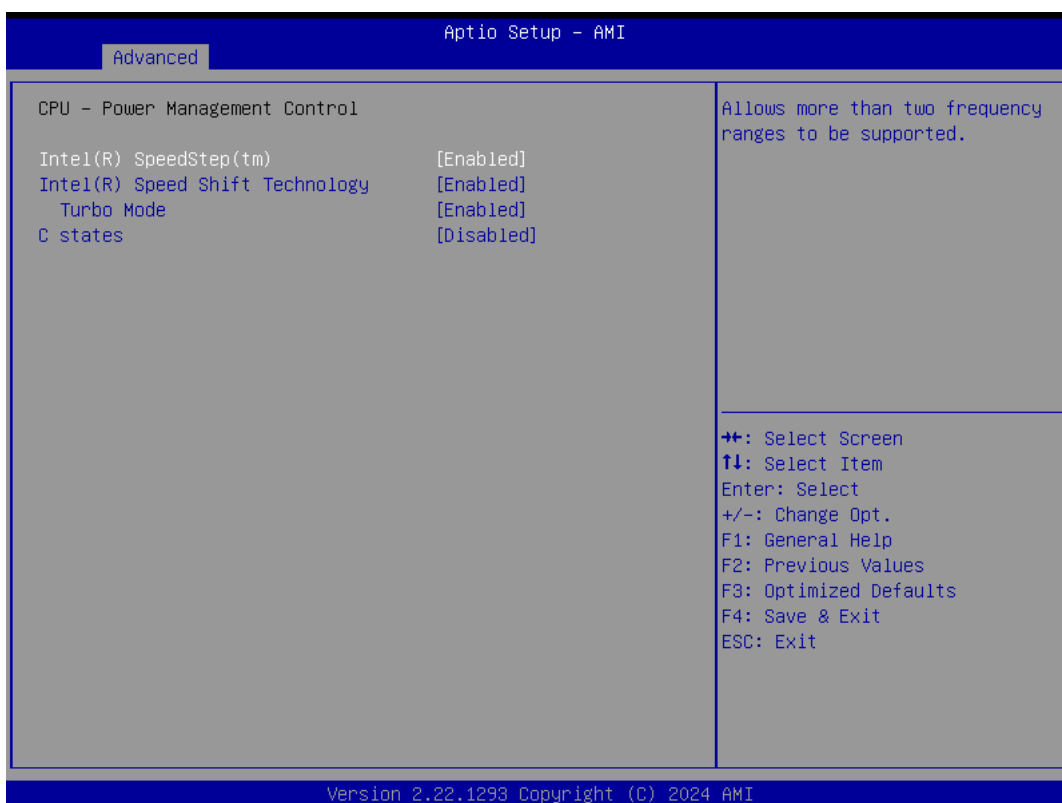

- **Intel(R) SpeedStep(tm)**
This item allows more than two frequency ranges to be supported.
- **Intel(R) Speed Shift Technology**
This item allows users to enable/disable Intel® Speed Shift Technology support. Enabling it will expose the CPPC v2 interface to allow for hardware controlled Pstates.

- **Turbo Mode**

This item allows users to enable/disable processor turbo mode (Intel Speed Step or Intel Speed Shift should be enabled).

- **C States**

This item allows users to enable/disable CPU power management. This will enable the CPU to go to C states when not 100% utilized.

3.2.2.3 PCH-FW Configuration

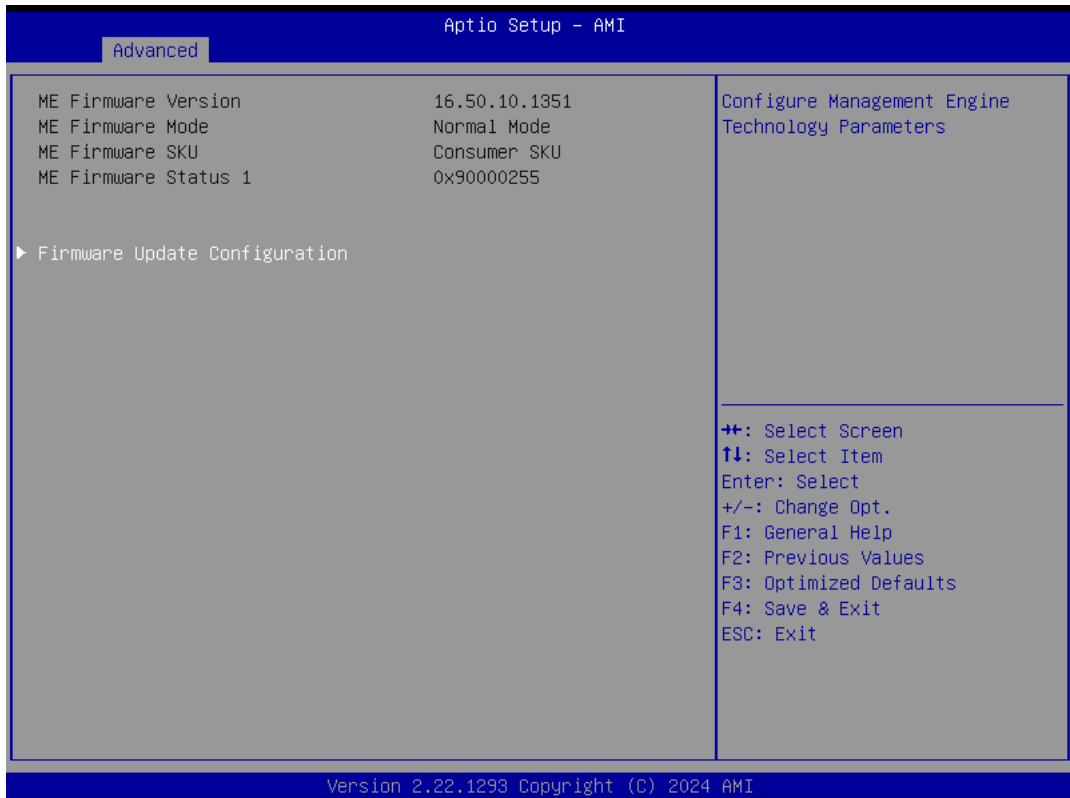

- **Firmware Update Configuration**

This item allows users to configure the management engine technology parameters.

3.2.2.4 Trusted Computing



- **Security Device Support**
This item allows users to enable/disable BIOS support for security devices. The OS will not show the security devices. The TCG EFI protocol and INT1A interface will not be available.
- **SHA256 PCR Bank**
This item allows users to enable/disable SHA256 PCR bank.
- **SHA384 PCR Bank**
This item allows users to enable/disable SHA384 PCR bank.
- **Pending Operation**
This item allows users to schedule an operation for the security device.
Note: The computer must be restarted to change the security device state.
- **Platform Hierarchy**
This item allows users to enable/disable platform hierarchy.
- **Storage Hierarchy**
This item allows users to enable/disable storage hierarchy.
- **Endorsement Hierarchy**
This item allows users to enable/disable endorsement hierarchy.
- **Physical Presence Spec Version**
This item allows users to enable support for PPI spec version 1.2 or 1.3.
Note: Some HCK tests may not support version 1.3.

3.2.2.5 ACPI Settings

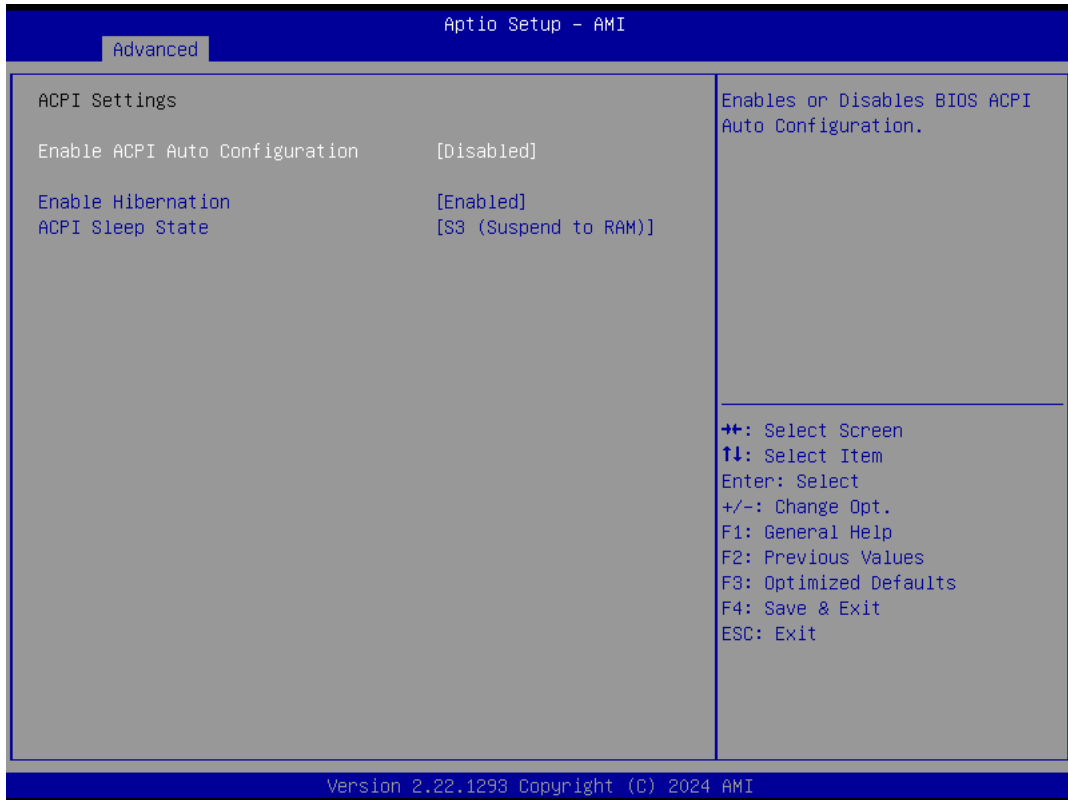

- **Enable ACPI Auto Configuration**
This item allows users to enable or disable “ACPI Auto Configuration”.
- **Enable Hibernation**
This item allows users to enable or disable System ability to hibernate (OS/S4 sleep state). This option may be not effective with some OS.
- **ACPI Sleep State**
This item allows users to select the ACPI sleep state. The system will enter when the SUSPEND button is pressed.

3.2.2.6 NCT6126D Super I/O Configuration



- **Serial Port 1 Configuration**
Set Parameters of Serial Port 1 (COMA).
- **Serial Port 2 Configuration**
Set Parameters of Serial Port 2 (COMB).

3.2.2.7 H/W Monitor Configuration

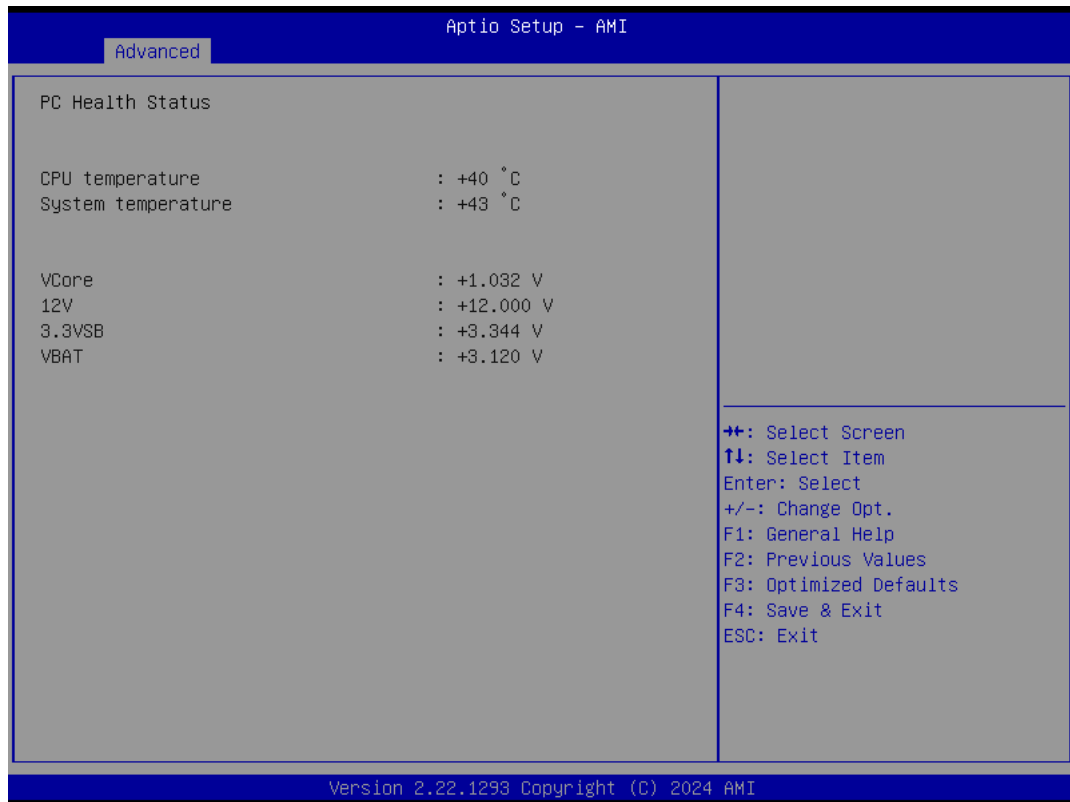

3.2.2.8 S5 RTC Wake Settings

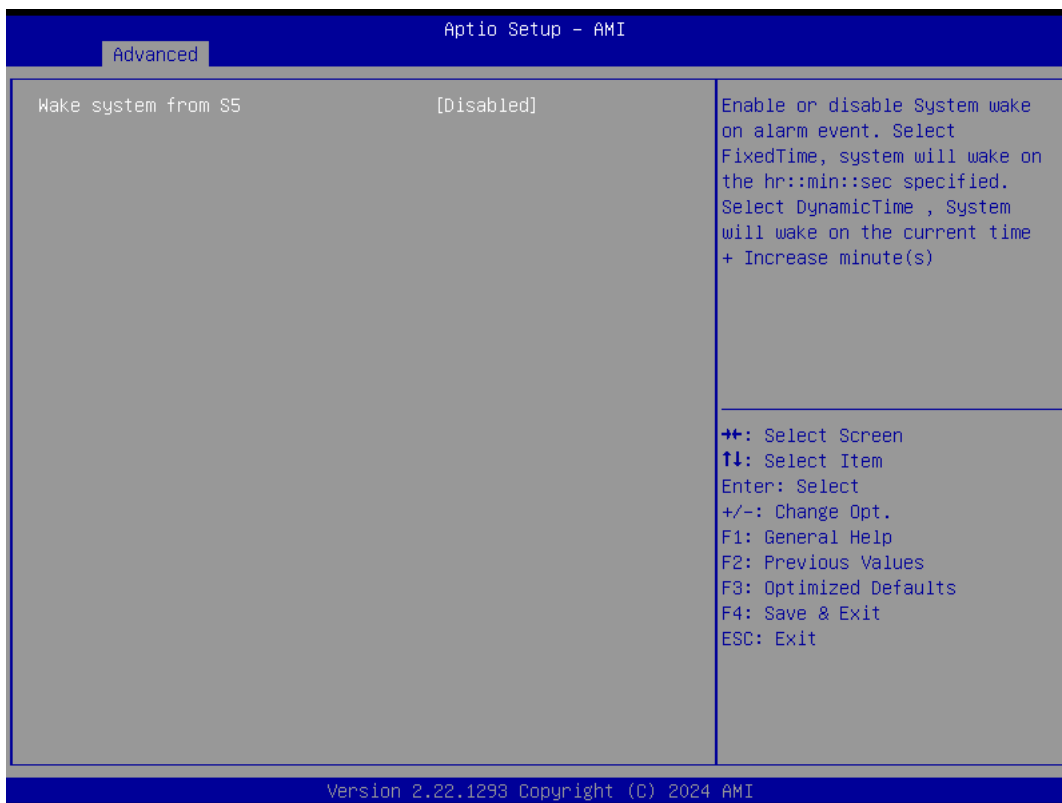

■ Wake System from S5

This item allows users to enable or disable system wake on alarm event. Select FixedTime, the system will wake on the hr:min:sec specified. Select DynamicTime, the system will wake on the current time + increased minute(s).

3.2.2.9 USB Configuration

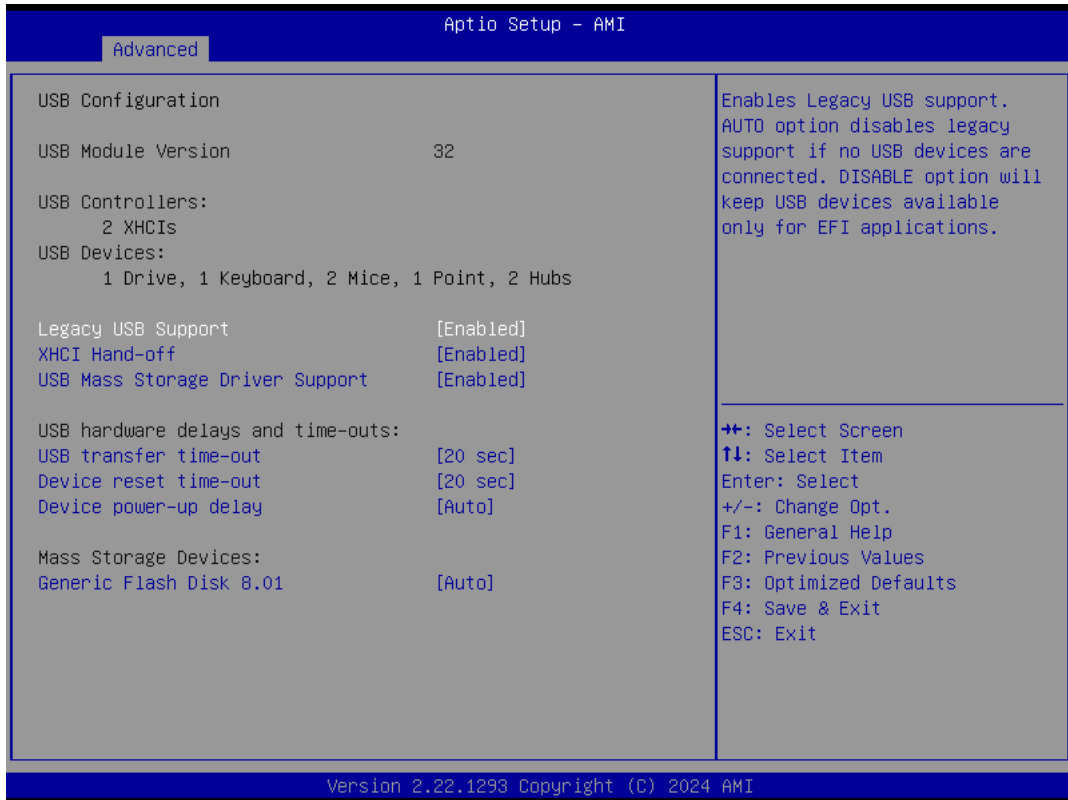

■ Legacy USB Support

This item allows users to enable/disable legacy USB support. Selecting the Auto option disables legacy support if no USB devices are connected. Selecting the Disable option will keep USB devices available only for EFI applications.

■ XHCI Hand-off

This is a workaround of 0 Secs without XHCI hand-off support. The XHCI ownership change should be claimed by XHCI driver.

■ USB Mass Storage Driver Support

Enable/Disable USB Mass Storage Driver Support.

■ USB Transfer Time-Out

This item allows users to set the time-out value for control, bulk, and Interrupt USB mass storage device transfers.

■ Device Reset Time-Out

This item allows users to set the device reset command time-out.

■ Device Power-Up Delay

This item allows users to Set the maximum time the device will take before reporting itself to the Host Controller. The Auto option uses the default value, which is 100 ms for a Root port. For a Hub port, the delay time is obtained from the Hub descriptor.

3.2.2.10 Network Stack Configuration

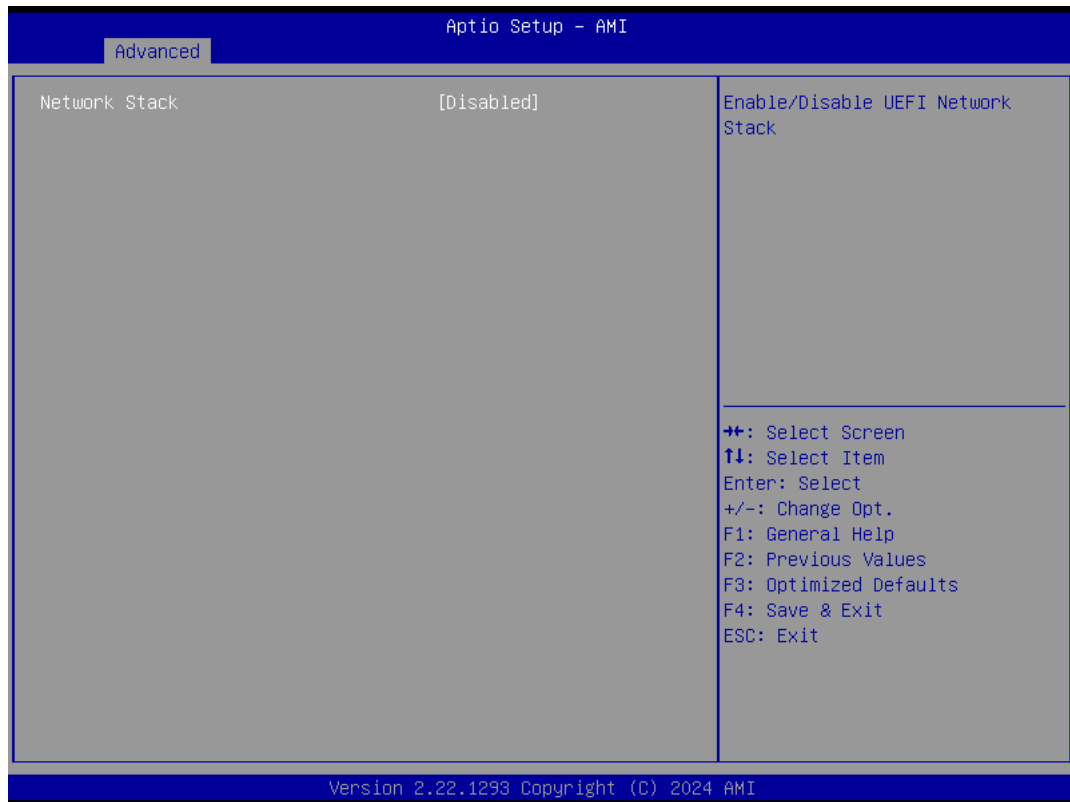

- **Network Stack**

This item allows users to enable or disable the UEFI network stack.

3.2.2.11 CSM Configuration

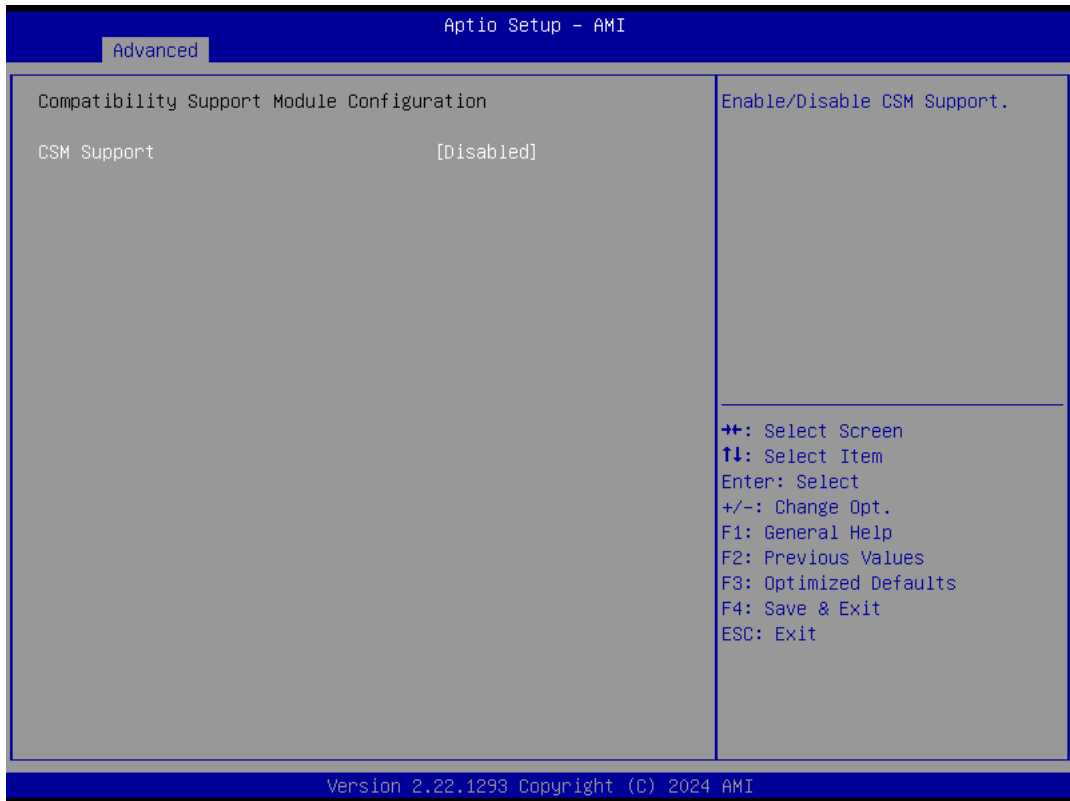

- **CSM Support**
Enable/Disable CSM Support.

3.2.2.12 NVMe Configuration

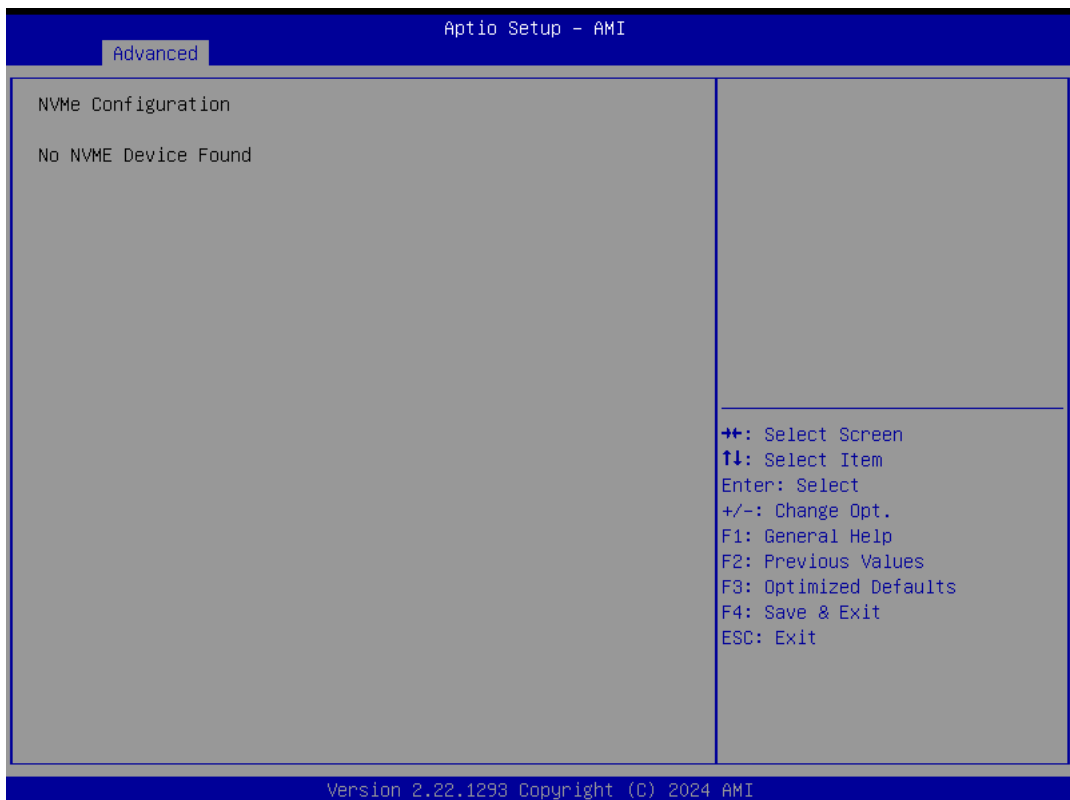

3.2.3 Chipset Configuration

3.2.3.1 System Agent (SA) Configuration

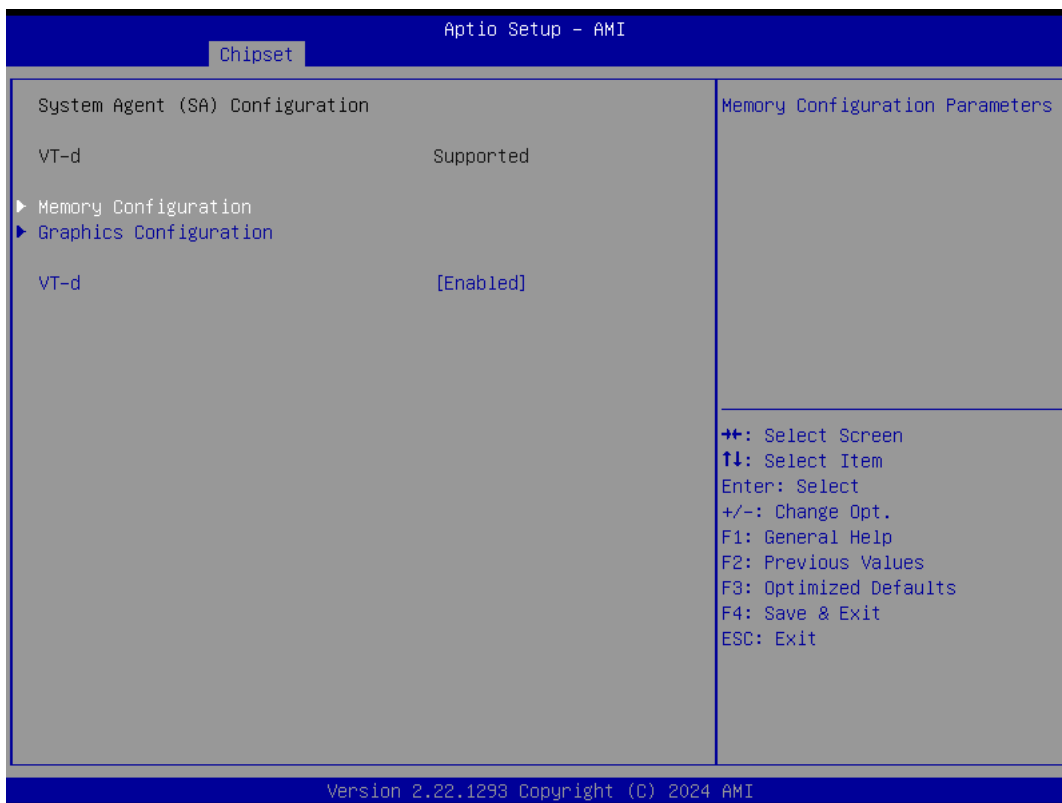

- **Memory Configuration**
This item allows users to view the memory parameters.
- **Graphics Configuration**
This item allows users to set graphics configuration parameters
- **VT-d**
This item allows users to enable or disable VT-d capability

3.2.3.2 PCH-IO Configuration



- **SATA Configuration**
This submenu allows users to set the SATA device settings.
- **Security Configuration**
This submenu allows users to set security configuration settings – BIOS lock, which allows users to enable or disable the PCH BIOS Lock Enable feature (required to be enabled to ensure SMM protection of flash).
- **Deep Sleep**
When this option is disabled, the PCIe Wake and Wake on Ring options can be selected.
- **PCIe Wake**
This item allows users to enable or disable the PCIe device to wake up the system from S3/S4/S5 state.
- **Wake on Ring**
This item allows users to enable or disable the Wake on Ring function.

3.2.4 Security



- **Administrator Password**
Set Administrator Password
- **Secure Boot**
This item allows users to access a submenu to configure secure boot settings.

3.2.5 Boot



- **Setup Prompt Timeout**
This item allows users to set the number of seconds to wait for setup activation key. 65535 (0xFFFF) means indefinite waiting.
- **Bootup NumLock State**
This item allows users to select the keyboard NumLock state.
- **Quiet Boot**
This item allows users to enable/disable quiet boot option.

3.2.6 Save & Exit

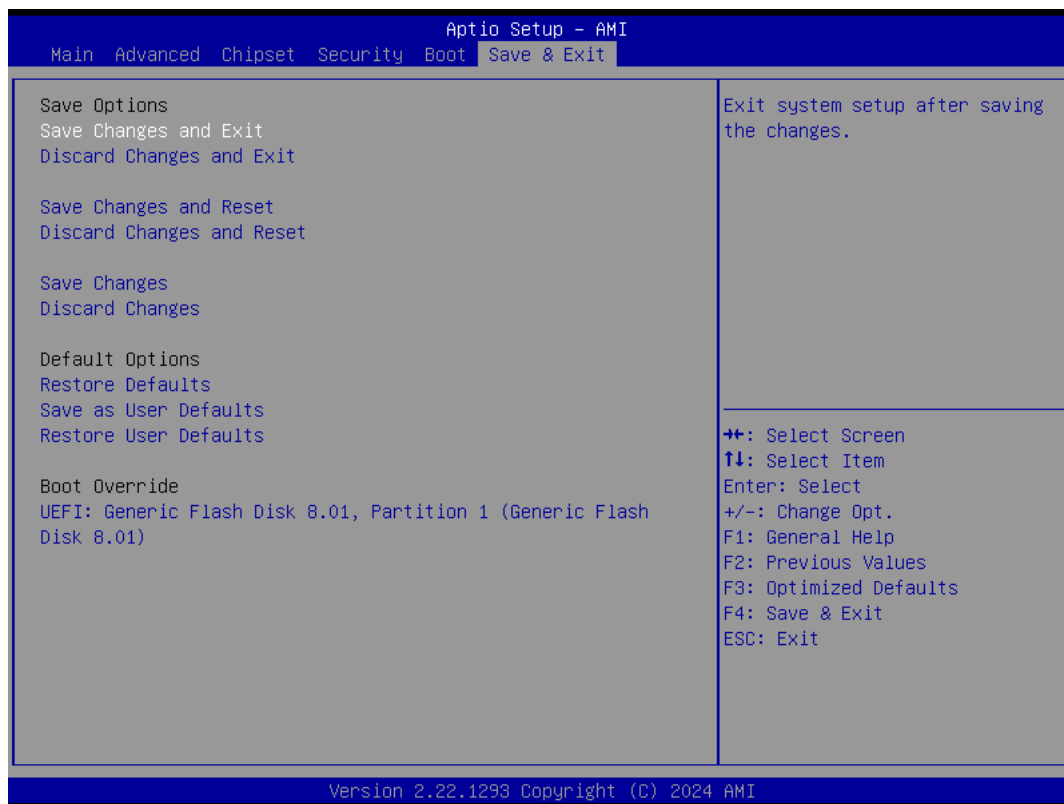

- **Save Charges and Exit**
This item allows you to exit system setup after saving the changes.
- **Discard Changes and Exit**
This item allows you to exit system setup without saving any changes.
- **Save Changes and Reset**
This item allows you to reset the system after saving the changes.
- **Discard Changes and Reset**
This item allows you to reset system setup without saving any changes.
- **Save Changes**
This item allows you to save changes done so far to any of the options.
- **Discard Changes**
This item allows you to discard changes done so far to any of the options.
- **Restore Defaults**
This item allows you to restore/load default values for all the options.
- **Save as User Defaults**
This item allows you to save the changes done so far as user defaults.
- **Restore User Defaults**
This item allows you to restore the user defaults to all the options.

Appendix **A**

Connectors

A.1 Jumper and Connector Location

A.1.1 Board Layout

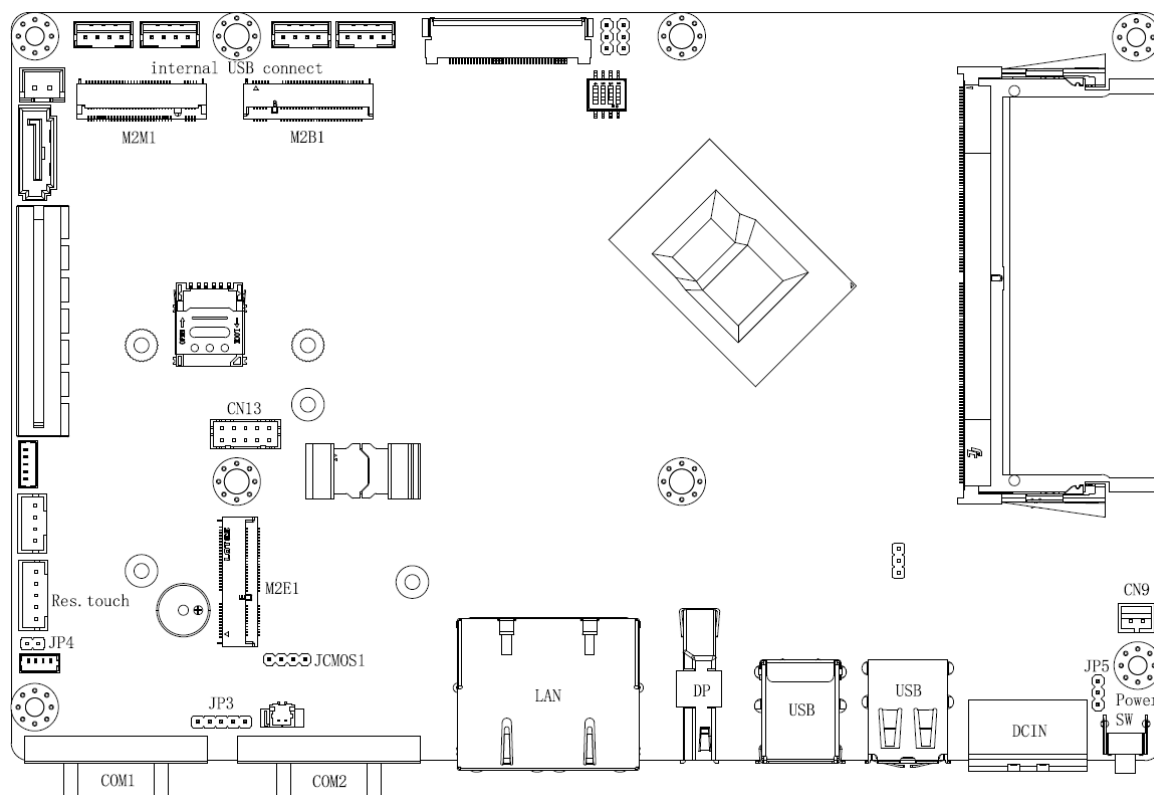

Figure A.1 Board Layout - Top View

Table A.1: Board Placement

Place	Function
JCMOS1	Clear CMOS jumper
JP3	COM1 Pin 9 power select jumper
JP4	Touchscreen type select jumper
JP5	ATX/AT mode select jumper
CN9	Remote power button connector
CN13	GPIO connector
COM1	COM1 RS-232/422/485 connector
COM2	COM2 RS-232/422/485 connector
M2B1	M.2 B-key 3042/3052 slot
M2E1	M.2 E-key 2230 slot
M2M1	M.2 M-key 2280/2242 slot

A.2 Jumper Settings and Descriptions

A.2.1 CMOS Clear Function (JCMOS1)

Table A.2: CMOS Clear Function

Description	This jumper is used to select CMOS clear
Default	(2-3)
(1-2)	CLR RTC Register
(2-3)	Normal (Default)
(3-4)	Clear CMOS

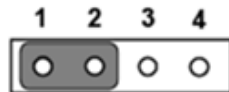

(1-2) CLR RTC Register

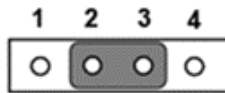
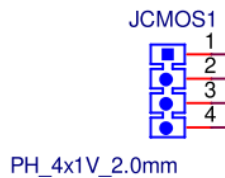

(2-3) Normal, default

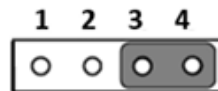

(3-4) Clear CMOS

A.2.2 COM1 Signal Select (JP3)

Table A.3: COM1 Signal Select

Description	This switch is used to select COM1 signal
Default	(1-2)
(1-2)	COM1 RI
(2-3)	COM1 Pin 9 5V
(4-5)	COM1 Pin 9 12V

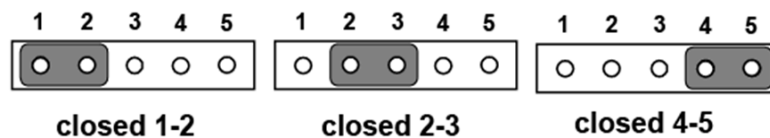

A.2.3 Touchscreen Type Select (JP4)

Table A.4: Touchscreen Type Select

Description	This jumper is used to select touchscreen type. Set JP4 jumper to short for resistive touchscreens; leave JP4 open for projected capacitive types.
Default	Short
Open	Projected capacitive type
Short	Resistive type

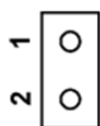

open



closed

A.3 Connector Pin Definition

A.3.1 Remote Power Button Connector (CN9)

Table A.5: Remote Power Button Connector (CN9)

Pin	Signal
1	ATX_PWRBTN#
2	GND



A.3.2 RS-232/422/485 Connector (COM1, COM2)

Table A.6: RS-232/422/485 Connector (COM1, COM2)

Pin	RS232	RS422	RS485
1	DCD	TX-	Data-
2	RX	TX+	Data+
3	TX	RX+	
4	DTR	RX-	
5	GND	GND	GND
6	DSR		
7	RTS		
8	CTS		
9	RI		

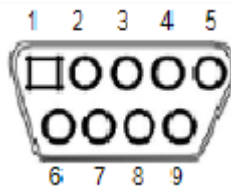

A.3.3 GPIO Connector (CN13)

Table A.7: GPIO Connector (CN13)

Pin	Signal
1	GND
2	GPIO4
3	GPIO0
4	GPIO5
5	GPIO1
6	GPIO6
7	GPIO2
8	GPIO7
9	GPIO3

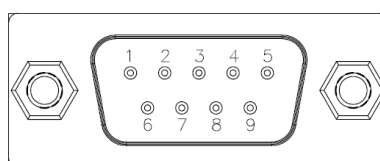

A.3.4 Ethernet Connector LEDs

Table A.8: 2.5G Ethernet Connector (LAN) LEDs

Speed LED		Activity/Link LED	
Off	10 Mbps	Off	No link
Off	100 Mbps	Green	Data activity & linked
Orange	1000 Mbps		
Green	2500 Mbps		

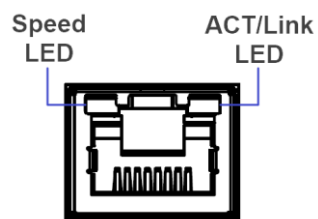

Appendix **B**

PCI / PCIe

B.1 Load Current of PCIe Slot

The total load current supported by the PCIe expansion slot is listed below.

Table B.1: Total Load Current of PCIe Slot

Voltage	Current
12 V	0.4 A
3.3 V	1 A
3.3 VSB	0.25 A

The total output power for 12V, 3.3V, and 3.3VSB should not exceed 10W.

B.2 Load Current of PCI Slot

The total load current supported by the PCI expansion slot is listed below.

Table B.2: Total Load Current of PCI Slot

Voltage	Current
12 V	0.2 A
5 V	0.4 A
3.3 V	1 A
3.3 VSB	0.2 A
-12 V	0.25 A

The total output power for 12V, 5V, 3.3V, 3.3VSB and -12V should not exceed 10W.

ADVANTECH

Enabling an Intelligent Planet

www.advantech.com

Please verify specifications before quoting. This guide is intended for reference purposes only.

All product specifications are subject to change without notice.

No part of this publication may be reproduced in any form or by any means, such as electronically, by photocopying, recording, or otherwise, without prior written permission from the publisher.

All brand and product names are trademarks or registered trademarks of their respective companies.

© Advantech Co., Ltd. 2024